

# dB

THE SOUND ENGINEERING MAGAZINE  
JUNE 1975 \$1.00



### IN THIS ISSUE:

- Audio in San Francisco
- Square Wave Generator for Audio
- Why Use 15ips Tape Speed?





# EVERYTHING AUDIO



**Studios by design...**

**not by accident**

Circle 10 on Reader Service Card

Accept our invitation to contact us and discuss your studio needs. 14045 Sherman Way, Van Nuys, California 91405 / (213) 873-444



**20. The Audio Cyclopedia (2nd ed.).** *Dr. Howard M. Tremaine.* New and updated, here is the complete audio reference library in a single volume. It provides the most comprehensive information on every aspect of the audio art. This new edition includes the latest audio developments including the most recent solid-state systems and integrated circuits. It covers all subjects in the fields of acoustics, recording, and reproduction with more than 3400 related topics. Each topic can be instantly located by a unique index and reference system. More than 1600 illustrations and schematics help make complicated topics masterpieces of clarity. 1760 pages, 6½ x 9¾ hardbound. **\$34.00**

**1. The Technique of the Sound Studio.** *Alec Nisbett.* This is a handbook on radio and recording techniques, but the principles described are equally applicable to film and television sound. 264 pages; 60 diagrams; glossary, indexed; 5½ x 8½; clothbound. **\$14.50**

**13. Acoustic Design & Noise Control.** *Michael Rettinger.* 1973. NEW. revised and enlarged edition covers physics of sound, room acoustics and design, noise and noise reduction, plus noise and its problems. Many charts and graphs. A practical and useful book. 562 pgs. **\$22.50**

**16. Magnetic Recording.** *Charles E. Lowman.* Reference guide to the technology of magnetic recorders used in audio recording, broadcast and closed-circuit TV, instrument recording, and computer data systems. Includes latest information on cassette and cartridge recorders; TV recorders; direct and FM signal electronics from low to wideband; servo-control and signal record/playback circuitry; capstan, reel, and head-drum servos for longitudinal, rotary, helical-scan, and disc recorders. Glossary, index, bibliographical information. 274 pp. **\$17.50**

**28. Environmental Acoustics.** *Leslie L. Doelle.* Applied acoustics for those in environmental noise control who lack specialized acoustical training. Basic information in comprehensible and practical form for solving straightforward problems. Explains fundamental concepts; pure theory minimized. Practical applications stressed, acoustical properties of materials and construction listed, actual installations with photos and drawings. Appendixes illustrate details of 53 wall types and 32 floor plans and other useful data. 246 pgs. **\$21.75**

**39. Reference Data for Radio Engineers.** *ITT Staff.* 5th Ed. The latest of one of the most popular reference books for radio and electronics engineers as well as libraries and schools. Complete, comprehensive reference material with tables, formulas, standards and circuit information. Contains 45 chapters. 1196 pages with hundreds of charts, nomographs, diagrams, curves, tables and illustrations. Covers new data on micro-miniature electronics, switching networks, quantum electronics, etc. **\$20.00**

**24. Basic Electronic Instrument Handbook.** *Edited by Clyde F. Coombs, Jr. Hewlett-Packard Co.* A basic reference background for all instruments. Offers saving in time and effort by having complete information in one volume on how to get the most benefit from available devices, how to buy the best instrument for specific needs. Reduces chances of costly errors. Ideal reference book, it is an excellent source for the beginner, technician, the non-electrical engineering man, or general non-engineering scientific and technical personnel. 800 pages. Hardbound. **\$29.50**

**25. Operational Amplifiers-Design and Applications.** *Burr-Brown Research Corp.* A comprehensive new work devoted entirely to every aspect of selection, use, and design of op amps—from basic theory to specific applications. Circuit design techniques including i.c. op amps. Applications cover linear and non-linear circuits, A/D conversion techniques, active filters, signal generation, modulation and demodulation. Complete test circuits and methods. 474 pages. **\$18.00**

**33. Noise Reduction.** *Beraneck.* Designed for the engineer with no special training in acoustics, this practical text on noise control treats the nature of sound and its measurement, fundamentals of noise control, criteria, and case histories. Covers advanced topics in the field. 1960. 752 pp. **\$26.00**

**32. Circuit Design for Audio, AM/FM, and TV.** *Texas Instruments.* Texas Instruments Electronics Series. Discusses the latest advances in design and application which represent the results of several years research and development by TI communications applications engineers. Emphasizes time- and cost-saving procedures. 1967. 352 pp. **\$18.00**

**31. Solid-State Electronics.** *Hibbard.* A Basic Course for Engineers and Technicians. An extremely practical reference book for anyone who wants to acquire a good but general understanding of semiconductor principles. Features questions and answers, problems to solve. 1968. 169 pp. **\$10.25**

**35. An Alphabetical Guide to Motion Picture, Television, and Videotape Productions.** *Leviton.* This all-inclusive, authoritative, and profusely illustrated encyclopedia is a practical source of information about techniques of all kinds used for making and processing film and t.v. presentations. Gives full technical information on materials and equipment, processes and techniques, lighting, color balance, special effects, animation procedures, lenses and filters, high-speed photography, etc. 1970. 480 pp. **\$24.50**

**40. Radio Transmitters.** *Gray and Graham.* Provides, in a logical, easy-to-understand manner, a working knowledge of radio transmitters for quick solution of problems in operation and maintenance. 1961. 462 pp. **\$17.50**

**37. Television Broadcasting: Systems Maintenance.** *Harold E. Ennes.* Covers maintenance of the t.v. broadcasting system from switcher inputs to antenna. Theory and operation of systems, tests and measurements, including proof of performance for both visual and aural portions of the installation. Many illustrations. A thorough treatment of modern television maintenance practice. 624 pgs. **\$16.95**

**41. Modern Sound Reproduction.** *Harry F. Olson.* A basic text covers amplifiers, microphones, loudspeakers, earphones, tape systems, film sound, tv and sound reinforcement—the significant elements and systems of modern sound reproduction. Employs simple physical explanations which are easily understood without special engineering training. Highly recommended text and reference. 328 pages. **\$18.50**



## Bookcase

As a service to our readers we are pleased to offer books from prominent technical publishers. All prices listed are the publishers' net. Shipping charges are included.

To order use the coupon below. Indicate quantity on the special instructions line if more than one copy of a title is wanted. Full payment must accompany your order. We cannot ship c.o.d. Checks or money orders should be made payable to Sagamore Publishing Company, Inc. Because of the time required to process orders, allow several weeks for the receipt of books.

Sagamore Publishing Company, Inc.  
1120 Old Country Road,  
Plainview, N. Y. 11803

Please send me the books I have circled below. My full remittance in the amount of \$\_\_\_\_\_ is enclosed. N.Y. State residents add 7% sales tax.

1	2	3	4	5	6	7	8	9	10	11
12	13	14	15	16	17	18	19	20		
21	22	23	24	25	26	27	28	29		
30	31	32	33	34	35	36	37	38		
39	40	41	42	43	44	45	46	47		

Name \_\_\_\_\_

Address \_\_\_\_\_

City \_\_\_\_\_

State \_\_\_\_\_ Zip \_\_\_\_\_

Special Instructions \_\_\_\_\_

Canada and foreign. Add \$1.00 per book

**38. Television Broadcasting: Equipment, Systems, and Operating Fundamentals.** *Harold E. Ennes.* An extensive text covering fundamentals of the entire television broadcast system. Excellent for new technicians and operators and as a source of valuable reference data for practicing technicians. Discusses NTSC color systems, camera chains, sync generators, recording systems, mobile and remote telecasts, t.v. antenna systems. Tables, glossary, exercises and answers. 656 pgs. **\$16.95**

**26. The Design of Digital Systems.** *John B. Peatman.* Textbook for students desiring to develop a creative approach to design capability through a digital systems approach. Answers these questions: Under what circumstances it is desirable to implement a system digitally? What are some of the components available for implementing the system? How do we go about designing it? 448 pages. **\$17.50**

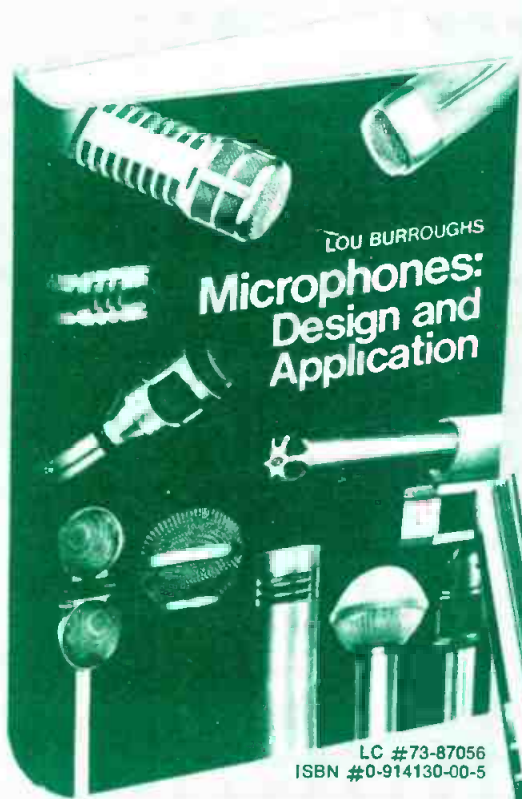

# If you work with microphones, you need this book!

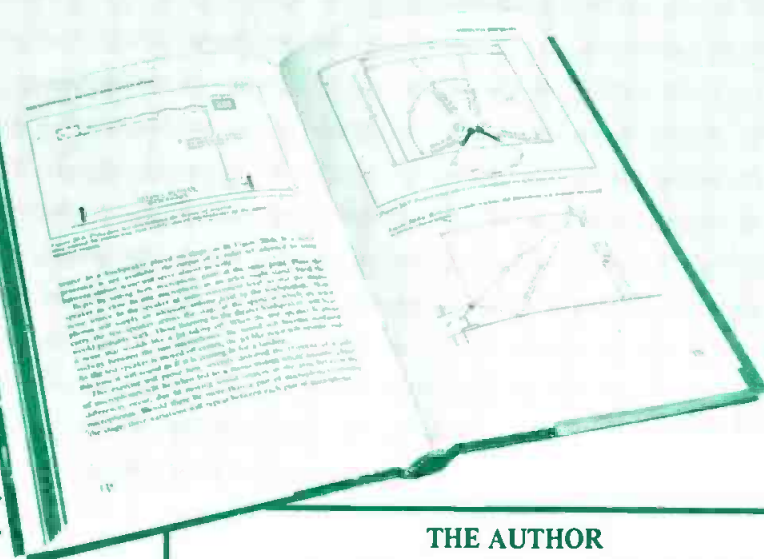

## The most important microphone book ever published.

A practical, non-theoretical reference manual for those involved in the application of microphones for tv, motion pictures, recording and sound reinforcement.

At last, the practical aspects of microphone design and application have been prepared and explained in one concise, fact-filled volume by one of audio's outstanding experts. This book is so full of useful information, we think you'll use it every time you face a new or unusual microphone problem.

### Perfect for Reference or Trouble-shooting

The twenty-six fact-packed chapters in this indispensable volume cover the field of microphones from physical limitations, electro-acoustic limitations, maintenance and evaluation to applications, accessories and associated equipment. Each section is crammed with experience-tested detailed information. Whatever your audio specialty — you need this book!

Along with down-to-earth advice on trouble-free microphone applications, author Lou Burroughs passes on dozens of invaluable secrets learned through his many years of experience.

He solves the practical problems you meet in day-to-day situations. For example:

- \* When would you choose a cardioid, omni-directional, or bi-directional mic?
- \* How are omni-directional mics used for orchestral pickup?
- \* How does dirt in the microphone rob you of response?
- \* How do you space your microphones to bring out the best in each performer?

This text is highly recommended as a teaching tool and reference for all those in the audio industry. Price: \$20.00

### THE AUTHOR

Holder of twenty-three patents on electro-acoustic products, Lou Burroughs has been responsible for extensive contributions in the development of the microphone. During World War II, he developed the first noise cancelling (differential) microphone, known as the model T-45. Used by the Army Signal Corps, this achievement was cited by the Secretary of War. Burroughs was the creator of *acoustalloy*, a non-metallic sheet from which dynamic diaphragms are molded. This material made it possible to produce the first wide-range uniform-response dynamic microphone. Burroughs participated in the design and development of a number of the microphones which have made modern broadcasting possible — the first one-inch diameter wide-range dynamic for tv use; the first lavalier; the first cardioid microphone (which ultimately won a Motion Picture Academy award) and the first variable-D dynamic cardioid microphone. He also developed the first wind screens to use polyester foam. Burroughs was one of the two original founders of Electro-Voice, Inc. He is a charter member of the Society of Broadcast Engineers and a Fellow member of the Audio Engineering Society.

### ORDER FORM

Sagamore Publishing Co., Inc.  
1120 Old Country Road, Plainview, N.Y. 11803

Please send [ ] copies of MICROPHONES: DESIGN AND APPLICATION at \$20.00 each.

Name \_\_\_\_\_

Address \_\_\_\_\_

City \_\_\_\_\_ State \_\_\_\_\_ Zip \_\_\_\_\_

Total amount \$ \_\_\_\_\_

N.Y.S. Residents add 7% Sales Tax \_\_\_\_\_

Enclosed is check for \$ \_\_\_\_\_

Foreign Orders add \$1 postage and handling



coming  
next  
month

● Sensurround, an illusion of motion through carefully contrived sound vibrations, made news in the motion picture, *Earthquake*. Meryl Altman's article **EARTHQUAKE—A MOVING EXPERIENCE**, tells the inside story.

● The engineer who always seems to have an answer to sudden ticklish problems, doesn't carry a magic wand. He owns one of Don Davis' **HANDY BLACK BOXES**. Mr. Davis describes the indispensable little items which every audio engineer should keep in his box, ready for instant use.

● A British look at the **ELECTRET MICROPHONE** is the contribution of Basil Lane, assistant editor of *Wireless World*. Mr. Lane describes the principle behind the permanently charged dielectric and other technical details of this miniaturized capacitor mic.

● Bonus **db** reprint brings back David L. Klepper's **ARCHITECTURAL ACOUSTICS, PART 2**, which many readers have requested for its clear instructions in designing studios to meet specific needs.

about  
the  
cover

● All of the recording studios shown here were photographed by Stephen Lampen for his article on audio in San Francisco (p. 26). Represented in this colorful montage are: Record Plant, His Master's Wheels, Columbia, Freeway Recording, Fantasy Records, Coast, Sierra Sound, Different Fur, and Wally Heider's.

**db**

THE SOUND ENGINEERING MAGAZINE

JUNE 1975, VOLUME 9, NUMBER 6

16	LASERIUM—LIGHT WITH MUSIC Martin Dickstein
26	HOW AUDIO IS DOING IN SAN FRANCISCO Stephen Lampen
32	COVERS AUDIO BAND IN ONE SWEEP James Davidson
34	ARCHITECTURAL ACOUSTICS—PART 1 David Klepper (Reprint)
40	WHY USE 15 IPS TAPE SPEED? Josef Dorner
42	RECORDING STUDIO ACOUSTICS—PART 6 Michael Rettinger
2	LETTERS
4	INDEX OF ADVERTISERS
6	CALENDAR
9	FREE LITERATURE
10	THE SYNC TRACK John Woram
12	THEORY AND PRACTICE Norman H. Crowhurst
14	SOUND WITH IMAGES Martin Dickstein
20	NEW PRODUCTS AND SERVICES
45	CLASSIFIED
48	PEOPLE, PLACES, HAPPENINGS

**db** is listed in **Current Contents: Engineering and Technology**

<b>Robert Bach</b> PUBLISHER	<b>Alex Porianda</b> MANAGING EDITOR
<b>Larry Zide</b> EDITOR	<b>John Woram</b> ASSOCIATE EDITOR
<b>Bob Laurie</b> ART DIRECTOR	<b>Hazel Krantz</b> COPY EDITOR
<b>Eloise Beach</b> CIRCULATION MANAGER	<b>Ann Russell</b> PRODUCTION
GRAPHICS <b>Crescent Art Service</b>	

db, the Sound Engineering Magazine is published monthly by Sagamore Publishing Company, Inc. Entire contents copyright © 1975 by Sagamore Publishing Co., Inc., 1120 Old Country Road, Plainview, L.I., N.Y. 11803. Telephone (516) 433 6530. db is published for those individuals and firms in professional audio-recording, broadcast, audio-visual, sound reinforcement, consultants, video recording, film sound, etc. Application should be made on the subscription form in the rear of each issue. Subscriptions are \$6.00 per year (\$12.00 per year outside U. S. Possessions, Canada, and Mexico) in U. S. funds. Single copies are \$1.00 each. Controlled Circulation postage paid at Harrisburg, Pa. 17105. Editorial, Publishing, and Sales Offices: 1120 Old Country Road, Plainview, New York 11803. Postmaster: Form 3579 should be sent to above address.

db June 1975 1

# ACTIVE EQUALIZERS SERIES 4000

## FEATURES

- \* 27 Channels on ISO 1/3 octave centers from 40 Hz to 16 kHz
- \* 10 dB boost or cut on continuous control
- \* Equal Q in both boost and cut
- \* Magnetically shielded for low hum pickup
- \* Variable low frequency cut
- \* No insertion loss
- \* All negative feedback for highly linear and stable operation
- \* Low noise
- \* Dual outputs with plug-in networks for bi-amp option.



Size: 3½" x 17"  
8½" deep

### MODEL 4001

Sound Reinforcement Model — Security Cover  
Rack Mounting — Transformer Coupled Input

### MODEL 4002

Music Reproduction Model — Rubber Feet For  
Table Use — Phono Type Connectors — Input Level  
Control

Black Anodized  
Aluminum Finish

Dealer Inquires  
Are Invited

*White*

Call or Write — White Instruments, Inc.  
P.O. Box 698, Austin, Texas 78767, Phone 512/892-0752

Circle 12 on Reader Service Card

Our selling premise is

# Simple...

## STL magnetic Test Tapes are the Most Comprehensive

We offer precision magnetic test tapes made on precision equipment for specific jobs in 1" and 2" sizes as well as flutter tapes and all other formats.

When you use STL test tapes you combine interchangeability with compatibility. You know you are using what other leaders in the professional recording, equipment manufacturing, government and educational agencies throughout the world are using.

Make sure your system is in step with the rest of the industry.

Write for a free brochure and the dealer in your area.  
Distributed exclusively by Taber Manufacturing & Engineering Co.



STANDARD TAPE LABORATORY, Inc.

2081 Edison Avenue  
San Leandro, CA 94577  
(415) 635-3805

Circle 13 on Reader Service Card

# db letters

## THE EDITOR:

Reference the article appearing in your January issue, audio certainly *did* get a big boost at Syracuse, thanks to the Newhouse publishing interests and the attention lavished on the Newhouse Communications Center. How times have changed!

I was Student Chief Engineer at the University's WAER from 1950-1953. The station had just increased power from 2½ watts (that's right! This was the forerunner of the 10-watt educational stations) to 1 kW. Remote recordings were made—in mono, of course—on reluctant Pentrons, and bulky two-unit-plus-power-supply PT6H Magnecorders were considered state-of-the-art. The poor engineer headed off to do a remote sports or music broadcast had to haul fifty or sixty pounds of remote box, power cable, mikes and all the rest.

Home-built mixing consoles, "adapted" disc recording amplifiers and the like notwithstanding, the radio-tv center turned out some remarkable work and some first-class professional broadcasters. With all of that wealth of new equipment to play with, let's hope that the students of today remember that it's the product. and not the means, that counts.

GEORGE W. HAMILTON  
(SYRACUSE UNIVERSITY, '53/'54)  
BEIRUT, LEBANON

## THE EDITOR:

Martin Dickstein's February column was most enjoyable.

However, he incorrectly describes the method used for getting sound of Fibber McGee's closet.

*Fibber McGee and Mollie* was originated from WLW in Cincinnati. On a tour of the station as a high school student in the mid-50's, I was shown the actual "closet." It was a wooden box, about 7 or 8 feet tall by 3 or 4 feet square. Inside were hinged shelves on which items were placed. The sound man would trip the shelves, causing the items to drop. A mic was placed in front of the closet; it did not have a solid door, but one made of slats to allow the sound to get to the mic.

Thanks for constantly producing a very interesting magazine.

RICHARD GOOD  
ADMINISTRATIVE VICE PRESIDENT  
COLUMBIA SCHOOL OF BROADCASTING  
SAN FRANCISCO, CA.

# Our new E series audio equipment will improve your sound and cut your costs . . . or your money back!



**TURNTABLE  
PREAMPS**



**MIC & LINE  
AMPLIFIERS**

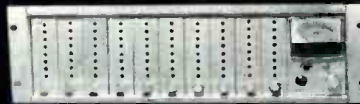

**AUDIO DISTRIBUTION AMPLIFIERS**



**AUDIO CONSOLES & CONTROLLERS**



**STUDIO MONITOR  
AMPLIFIERS**



**REMOTE POWER  
CONTROLLERS**



**AUTOMATIC TAPE CARTRIDGE  
& CASSETTE LOADERS**

## TEN DAY FREE EVALUATION AND 2 YEAR GUARANTEE INSURE YOUR UNCOMPROMISED SATISFACTION

### TURNTABLE PREAMPS

Preamps costing almost 3 times more will not compare with these units. RIAA/NAB equalized  $\pm 1$ db, 0.5MV sensitivity at 1KHz for +4dbm out, balanced outputs, -75db s/n at 10mv in, 0.05% distortion, +21dbm max. out. Internal power supply.

MP-8E Mono \$86 SP-8E Stereo \$137

### MIC & LINE AMPLIFIERS

Dual function and superb performance. Inputs for mic and line,  $\pm 0.5$ db response 10Hz-20KHz, 67db gain on mic channel(s) +26db gain on line inputs. Balanced inputs & outputs, +21dbm out max. 0.1% distortion. Internal power supply.

MLA-1E Mono \$98  
MLA-2E Dual Mono/Stereo \$139

### AUDIO DISTRIBUTION AMPLIFIERS

From 1 in/6 out to 20 in/80 out in one small package. Whatever your distribution requirements we have an answer. All units meet or exceed the following specifications: Balanced bridging/matching inputs, balanced 600ohm outputs,  $\pm 0.5$ db response 10Hz-20KHz,  $\pm 3$ db 5Hz-40KHz, 26db gain, +21dbm out. max. capability, 0.1% or less distortion, outputs isolated by 80db, hum and noise 90db down referenced to +21dbm out. Internal power supplies.

DA-6/E	Table top. 1 in/6 out.	\$131
DA-6R/E	Rack mount. 1 in/6 out.	\$149
DA-6BR/E	Rack mount. 1 in/6 out. Individual level controls for each output.	\$165
DA-6RS/E	Rack mount. 1 in/6 out stereo or 2 in/12 out mono.	\$229
DA-16BR/E	Rack mount. 1 in/8 out stereo or 2 in/16 out mono. Individual output level controls, selectable metering & headphone monitoring.	\$287
DA-2080/E	Rack mount main frame with protected	

power supply, metering & headphone monitor. Will accept up to 10 slide in modules. Each module has 2 inputs & 8 outputs. Individual output level controls & selectable meter switch. Up to 20 in/80 out.

DA-2080/E	Main Frame	\$150
DA-2080/E	Modules 2 in/8 out	\$135 ea.

### AUDIO CONSOLES & CONTROLLERS

Our new series 35 audio controller introduces a new concept in audio mixing. Allows separation of controls from the audio functions. Controls can be placed in any convenient location in the studio, while electronics may be mounted anywhere for easy maintenance & hookup. Remote DC control for completely unaffected audio.

This versatility gives you a custom designed console at a standard production model cost.

Features include; 8 channels, mono, dual channel mono, stereo, dual channel stereo, or combinations; paralleling 2 units for quad, fail safe power supply & plug in interchangeable cards.

Performance specifications are; 0.3% or less distortion, 124dbm equivalent noise on low level channels, approximately 25w power consumption, -70db crosstalk, balanced bridging/matching inputs & response within  $\pm 2$ db 20Hz-20KHz. Series 35 audio controllers start at \$1200.

### AUTOMATIC TAPE CARTRIDGE AND CASSETTE LOADERS

So easy to use & accurate that our largest winder competitor has been using one of these to load their own carts.

Eliminates guesswork. Set the dials to the length desired. The exact amount of tape is fed onto the cart or cassette hub and then shuts off automatically. Also has exclusive torque control for proper tape pack on different size hubs. Winds at 30 IPS.

ACL-25/E		\$185
----------	--	-------

Winders also come in higher speed models (ACL-60 series). Same operation as above but winds at 60 IPS. Accepts 14" pancakes.

ACL-60T/E	(tone stop only)	\$266
ACL-60B/E	(Blank tape loader)	\$331
ACL-60BT/E	(for both prerecorded and blank tape)	\$375

### STUDIO MONITOR AMPLIFIERS

Exceptional reproduction! Internal muting.  $\pm 2$ db response from 20Hz-40KHz. 25w music power, 20w RMS into 8 ohms. Hum & noise 65db below rated outputs.

Distortion less than 0.25% at less than 20w out, 1% or less at 20w. Works into 4-16ohms. Balanced bridging inputs, variable bass contour, internal overload & short circuit protection.

SMA-50/E	Table top (mono)	\$125
SMA-500/E	Rack mount (mono)	\$142
SMA-1000/E	Rack mount (stereo-40w)	\$196

### REMOTE POWER CONTROLLERS (DUAL)

Safe, transient free means of controlling 110V/AC. Turntables, on the air lights, etc.

PR-2	(toggle switch on/off)	\$39
PR-2B	(momentary contact actuation)	\$54

Give us a call or write today for further details. You'll be money and performance ahead.

CALL COLLECT — (916) 392-2100  
WRITE — 3516-C LaGrande Boulevard  
Sacramento, California 95823

## RAMKO RESEARCH

Circle 14 on Reader Service Card



# AUDIOWAVES

The perfect beginning.  
RCA Microphones

Sound decisions start with a microphone. That's why RCA offers a complete line.

There are velocity, pressure and dynamic mikes to choose from. And when you want particularly faithful reproduction of speech or music, RCA ribbon microphones, with their excellent bass response, are what you need.

See your RCA representative. It could be the perfect beginning of a sound relationship. RCA Broadcast Systems, Camden, N. J. 08102.

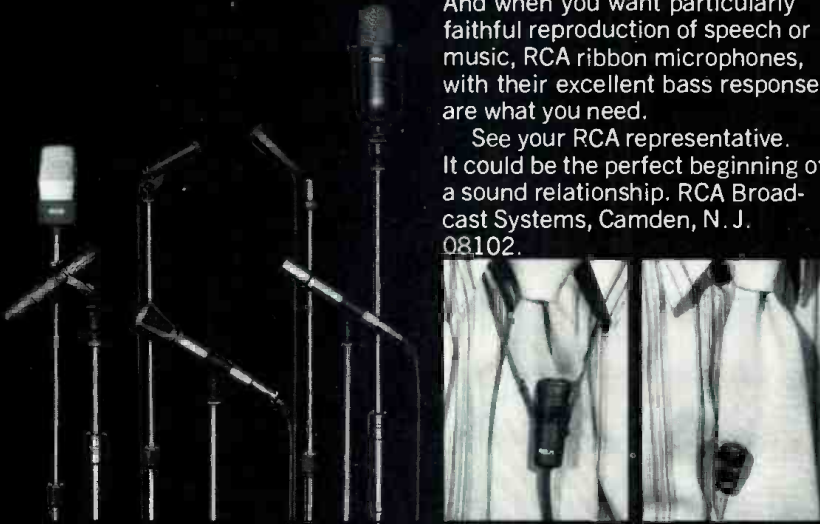

## RCA

Microphones • Consoles • Tape and Transcription Equipment  
Automation Systems • Amplifiers and Speakers

Circle 15 on Reader Service Card

The best by far...  
because Revox delivers what  
all the rest only promise.



For complete details write:  
Revox Corp., 155 Michael Drive, Syosset, N.Y. 11791

Circle 16 on Reader Service Card

## index of advertisers

Amber	31
Audio Design	33
Audiomatic	8
Audionics	16
Bang & Olufsen	37
BGW	19
Bose Corporation	39
Crown International	18, 25
Electro-Voice	Cover 4
EMT	9
ESE Digitals	44
Everything Audio	Cover 2
Garner Industries	18
Gotham Audio	15
Lumiere	6
MXR Innovations	7
Neumann	11
Rupert Neve	30
Peavey Electronics	21
Philips Audio (AKG)	5
Polyline	9
Precision Electronics	6
Ramko Research	3
Rauland-Borg	17
RCA	4
Revox	4
RIA Tapes	23
Sescom	19
Sound Genesis	22
Southwest Technical Products	24
Standard Tape Labs	2
TEAC Corp. of America	Cover 3
Telefunken	13
Timekeeper	47
White Instruments	2
Woram Audio	47

## db sales offices

### THE SOUND ENGINEERING MAGAZINE

#### New York

1120 Old Country Rd.  
Plainview, N.Y. 11803 516-433-6530

#### Roy McDonald Associates, Inc. Dallas

Stemmons Tower West, Suite 714  
Dallas, Texas 75207 214-637-2444

#### Denver

3540 South Poplar St.  
Denver, Colo. 80237 303-758-3325

#### Houston

3130 Southwest Freeway  
Houston, Tex. 77006 713-529-6711

#### Los Angeles

500 S. Virgil, Suite 360  
Los Angeles, Cal. 90020 213-381-6106

#### Portland

2035 S. W. 58th Ave.  
Portland, Ore. 97221 503-292-8521

#### San Francisco

Suite 265, 5801 Christie Ave.  
Emeryville, Cal. 94608 415-653-2122



In miking a drum set or other instruments for which greater separation is required, the C-414 has a hyper-cardioid pattern (in addition to switchable cardioid, omni or figure-eight).

For a close range vocalist, brasses or other sources generating high sound pressure levels, the C-414 is capable of handling 124 dB SPL with less than 1% distortion (THD of complete system, including capsule; whereas others specify preamp. only) and if all else fails, the C-414 has a switchable 10 dB pad to prevent overload of its own preamplifier and your inputs.

And to help you cope with dynamic range, the C-414's equivalent noise level is 21 dB (DIN 45405).

You can power it directly from your console (standard 24 v. B+). It doesn't require a special card. It's also fully compatible with the popular AKG C-451E. Both were designed to make you happy.

The C-414 will live up to your standards. Contact your professional equipment supplier or write directly to us.

**AKG MICROPHONES • HEADPHONES**  
PHILIPS AUDIO VIDEO SYSTEMS CORP.  
AUDIO DIVISION  
91 McKee Drive, Mahwah, N.J. 07430  
A North American Philips Company



## **The AKG C-414**

**It's all a matter of professional judgment.**

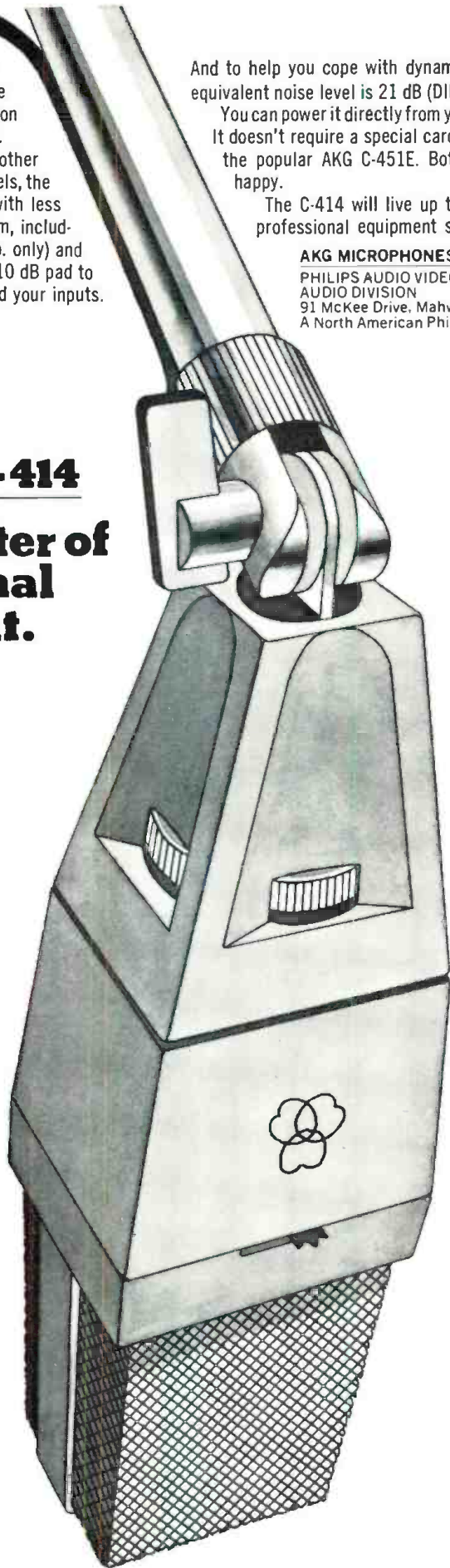



**Clear-Com**  
 'communication in every event'



**Clear-Com**  
 Portable Intercom Systems

A division of Lumiere Productions  
 759 Harrison Street, San Francisco, Ca. 94107  
 (415) 989-1130

Circle 18 on Reader Service Card

THE NAME AND THE PRODUCT THAT **sets the standard for P.A. equipment**

Whatever your PA needs, from a small office to large auditorium, with amplifiers in every power range, including mobile, Precision Electronics delivers the product and value . . . including an entire line of accessories. Get all the facts, without obligation, on the "right sound" for your needs. Complete and mail this coupon today.

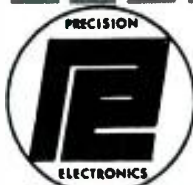

NAME \_\_\_\_\_  
 COMPANY \_\_\_\_\_  
 ADDRESS \_\_\_\_\_  
 CITY \_\_\_\_\_ STATE \_\_\_\_\_ ZIP \_\_\_\_\_  
 Mail to: **PRECISION ELECTRONICS, INC.**  
 9101 King St., Franklin Park, Illinois 60131



Circle 19 on Reader Service Card

**CALENDAR**

**JUNE**

- 9-27 **Brigham Young University Audio Recording Technology Course.** Contact: Russel Peterson, Brigham Young University, Audio Recording Technology Course, 242 Herald R. Clark Building, Provo, Utah 84602. Phone: (801) 374-1211, ext. 3784.
- 15-18 **AMTEC '75, Canadian Educational Communications Conference of the Association for Media and Technology in Education,** Calgary, Alberta, Canada. Contact: Garry Smith, ACCESS Television South, Calgary Health Sciences Centre, 1611 29th St. N.W., Calgary, Alberta T2N 4J8.

**JULY**

- 7-11 **Nashville Audio Exhibition seminar.** Contact: Nashville Audio Exhibition, P.O. Box 12123, Nashville, Tenn. 37212. (615) 327-3918.
- 8-11 **INTER NAVEX '75 (Audio Visual Aids in Education)** London.

**SEPTEMBER**

- 15-17 **NOISE-CON '75 National Conference on Noise Control Engineering.** Gaithersburg, Md. Pre-seminar at the Shoreham Hotel, Washington, D.C. Sept. 11-13. Contact (914) 462-6719.
- 28-Oct. 3 **SMPTE Technical Conference and Equipment Exhibit.** Century Plaza Hotel, Los Angeles. Contact: SMPTE Conference, 862 Scarsdale Ave., Scarsdale, N.Y. 10583.
- 29-30 **N.Y. Chapter of ERA, Commercial Sound & Communications Show,** Statler-Hilton Hotel, New York City. Contact: GIM Sales Corp., 375 N. Broadway, Jericho, N.Y. 11753 (516) 433-4080.

**OCTOBER**

- 21-26 **International Audio Festival Fair.** London, England. Contact: British Information Service, 845 Third Ave., New York, N.Y. 10022. (212) 752-8400.



# PHASING vs FLANGING

*the discernible difference*

**Phaser:** An effects component designed to produce a phase-shift response created by a comb-filter effect with frequency-related notches which is mixed back with the original signal.

The effect of phasing is obtained by passing the input signal through a series of all-pass filters exhibiting a phase response that is variable in frequency. When this signal is mixed back with the input signal, cancellations and reinforcements occur. The resulting comb-filter effect spreads over a wide range of frequencies. As these notches are moved up and down the audio range, a spacious, spinning effect is obtained.

The subjective effect of phasing is best at mid and low frequency ranges, as opposed to flanging, phasing's chronological predecessor.



**Flanger:** An effects component created by MXR Innovations to provide repeatable reel-flanging effects, caused by mixing a dry and a time delayed signal to create a comb-filter response with harmonically related components.

The effect of flanging is created by mixing a variable time delay signal back with the original dry signal. The resulting comb-filter response is characterized by the precise mathematical relationship created by the time delay.

The subjective effect is that of conventional reel-flanging, without the necessity for manpower and multiple tape decks or a costly and highly specialized digital delay system. The comb-filter response of flanging causes random program material (i.e. drums, cymbals and other percussion) to take on musical tonality. Unlike phasing, flanging is subjectively more noticeable at mid and high frequencies, due to the time delay created response. Unlike reel-flanging, the MXR Auto Flanger is at the tip of your fingers in real time.

You will find the Auto Flanger and Auto Phaser to be wise additions to any studio effects board. Compact and fully compatible with existing systems, both components are easily incorporated with the mere addition of a simple power supply (+ 15 to + 30V).

Once installed, the units' ease of operation and versatility will revolutionize your effects board.

External control capabilities allow for stereo operation of two units, and low power consumption ensures multiple use without excessive drain on your board supply. Both units are durable, reliable, affordable . . . innovative — and are internationally available at leading audio supply houses.



**MXR Innovations, Inc.**

Professional Products Group, 277 N. Goodman St., Rochester, N.Y. 14607

Circle 20 on Reader Service Card

# You'll find what you need

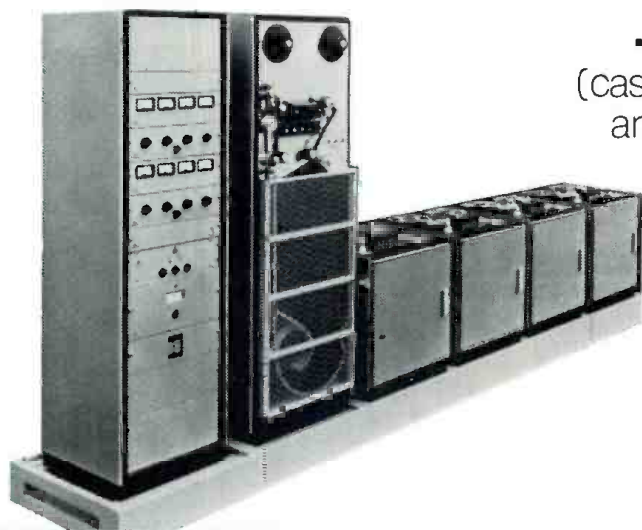

## ...for Tape Duplicating

(cassette, 8-track, open reel or any combination) for music, industry, education in the Electro Sound line from

**audio**  
AUDIOMATIC CORPORATION

# You'll find what you need

## ...for Tape Mastering, or Studio Recording

(mono- $\frac{1}{4}$ " to 8-track-1" or any combination) in the ES 505 Pro Recorder line from

**audio**  
AUDIOMATIC CORPORATION



# You'll find what you need

...for Quality Control  
of pre-recorded pancakes  
(cassette, quad, 8-track or any combination) in the Electro Sound line from



**audio**  
AUDIOMATIC CORPORATION

1290 AVENUE OF THE AMERICAS  
NEW YORK, N. Y. 10019. PHONE: (212) 582-4870  
CABLE: AUDIOMATIC/TELEX: 12-6419  
OVERSEAS OFFICE: 4 RUE FICATIER  
92400 COURBEVOIE, FRANCE. PHONE 333 30.90  
CABLE: AUDIOMATIC/TELEX: 62282



## FREE LITERATURE

To obtain the free literature described, please circle the appropriate number on the Reader Service Card in the back of the magazine.

### LOW-COST MINIATURIZED POWER SUPPLIES

Engineering bulletin provides typical schematics and suggested components for construction of low-cost, miniaturized, unregulated and regulated power supplies. Mfr: Microtran Co., Inc.

Circle No. 80 on R.S. Card

### AUDIO HEAD REPLACEMENT GUIDE

A 24-page catalog containing about 350 heads with cross references for equipment produced by most major professional recorder manufacturers. Mfr: Nortronics Co., Inc.

Circle No. 81 on R.S. Card

### INTERFACING COS/MOS SYSTEMS

8-page application note providing examples of practical circuits for interfacing situations between COS/MOS and other technologies. Mfr: RCA.

Circle No. 82 on R.S. Card

### CONNECTORS AND COMPONENTS

Card edge connectors, p.c. varicon receptacles, rack and panel receptacles, contact strips, and card enclosures are listed in this 32-page catalog. Mfr: C. Tennant Electronics.

Circle No. 83 on R.S. Card

### INSTRUCTIONAL VIDEO TAPES

A list of video tapes on technical electronics subjects are included in this 24-page 1975 catalog. Subjects include a tutorial series on transistor theory, trouble-shooting solid-state circuits, and digital electronics. Some available in languages other than English. Mfr: Hewlett-Packard.

Circle No. 84 on R.S. Card

### BI-MONTHLY NEWSLETTER

The Sibley News, a two-page newsletter is published bi-monthly, reporting on printed circuit design, wiring, production, or packaging. Mfr: The Sibley Co.

Circle No. 85 on R.S. Card

### LOUDSPEAKER ENCLOSURES

"Loudspeaker Enclosures — Their Design and Use," is a 32-page publication aimed at those who wish to build their own cabinets for raw frame speakers. Mfr: Altec.

Circle No. 86 on R.S. Card

### OSHA NOISE COMPLIANCE

Equipment needed to comply with

OSHA's noise regulations are described, with charts, in this brochure.

Mfr: B & K Instruments.

Circle No. 87 on R.S. Card

### TRANSFORMERS, INDUCTORS, POWER SUPPLIES

More than 30 categories of transformers, including autoformers, bridging, CRT power, driver, geoforner, input and interstage are covered in this 52-page 1975-6 "Catalog of Transformers, Inductors, Power Supplies and Circuit Cards for Industry."

Mfr: Litton Industries (Triad-Utrad).

Circle No. 88 on R.S. Card

36 types of empty tape reels and boxes  
for hi-speed duplicating audio spots - tv spots  
IMMEDIATE SHIPMENT FROM MANUFACTURER'S STOCK  
GET CATALOG PD 175  
Polyline CORP. 312/298-5300  
1241 Rand Rd. DesPlaines, IL 60016

Circle 22 on Reader Service Card

# A MARK OF QUALITY

## ON THE FOLLOWING PRODUCTS:

- Reverberation Units
- Studio Turntables and Pickups
- Compressors, limiters and noise filters
- Digital audio signal delay units
- Auditorium microphone winch systems
- Specialized tape machines for endless loop cassettes and logging purposes
- Electronic tuning fork and polarity tester
- Wow and flutter test equipment

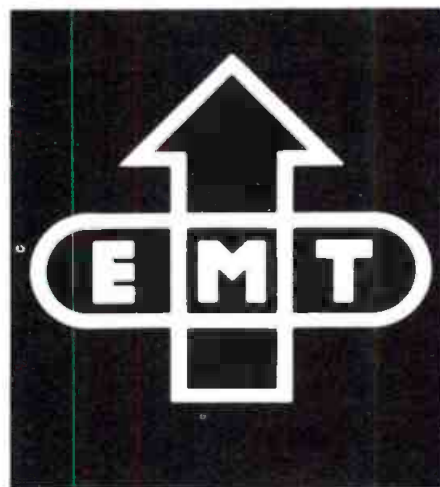

Outside the U.S.A. contact:

AUDIO TECHNOLOGY

**EMT-FRANZ** VG mbH.

P.O.B. 1520 D-7630 LAHR-1

W. Germany

Cables: MESSTECHNIK LAHR

Phone: (07825) 512

Telex: 754319



Circle 23 on Reader Service Card

● Archeologists tell us that many years ago, recording engineers used a device known as a tape delay system. Usually, signals on their way to a reverberation chamber were first fed through this auxiliary machine, so that they were delayed a bit on their way to the chamber.

The system worked, but was inflexible, noisy, and a nuisance. The delay tape would run out in the middle of the ultimate mix, and the delay time was either too long or too short, depending on the speed of the machine. Today, all the beautiful people are using digital delay lines. You feed the signal into a black box where God knows what is going on inside. A little while later, the signal pops out the other end, none the worse for wear. On the front of the black box are some controls, and you simply dial up the amount of delay you need. That's all there is to it—no rewinding of tape, no fiddling with a capstan to get the delay you want. And no moving parts (except electrons).

The delay line is one of the first applications of digital techniques in audio. And now there are those new tape recorders that confuse so many of us with their logic systems. The logic system knows more about what you want to do than you do, and you must never make it angry! It's usually got a built-in fail/safe system, which is the first thing to crap out. This means that when you press "stop," the machine may perform the following functions:

1. Stop.
2. Go into record mode.
3. Go into fast forward.
4. All, or none, of the above.

Your maintenance department does not want to hear about it, for there are neither tubes to tap, nor pulleys to pluck. There may not even be a spring to snap. In short, the machine is unfixable. Unless you know something about

#### DIGITAL TECHNIQUES IN AUDIO

This was the subject discussed recently at the 1975 Midwest Acoustics Conference, a joint venture of the Audio Engineering Society's Chicago section, the Acoustical Society of America, the Institute of Electrical and Electronics Engineers, the Chicago Acoustical and Audio Group, and Northwestern University. This year's

conference President—or Big Mac—was Bob Schulein of Shure Brothers, who got things under way with a talk by Dr. Barry Blesser on *Digital Processing of Audio Signals*. Dr. Blesser gave us some idea of what digital audio is all about.

Consider the problem of transmitting an infinite number of voltages, lying between, say, zero and 5V. If we have a 5V source available at a switch,  $S_a$ , we can transmit either 5V or zero V, depending on the condition of the switch. Not very promising, if we wish to transmit *any* voltage between these two levels. If we add a second switch,  $S_b$ , which will supply a voltage of  $0.5S_a = 2.5V$ , we now have four choices. (5 + 2.5, 5, 2.5, 0). With a third switch,  $S_c = 0.5S_b = 1.25V$ , we have 8 choices. (5 + 2.5 + 1.25, 5 + 2.5, 5 + 1.25, 5, 2.5 + 1.25, 2.5, 1.25, 0). The number of voltages available increases by the square of the number of switches, so the system's capability for transmitting any desired voltage increases rapidly as switches are added, while the error factor decreases just as quickly.

Since each switch is either on or off, we can represent all possible combinations by a series of zeroes (off) and ones (on). So what?

Well, if we pick some convenient d.c. voltage that happens to be lying around, we can transmit a series of pulses, each of which represents a "switch on" condition. No pulse means either the system isn't working, or the switch is in the *off* condition. To eliminate this ambiguity, another voltage level is usually used to signify zero. Now, at one end of the transmission medium, the (analog) voltage to be transmitted is converted into a series of (digital) pulses. At the other end, the pulses are converted back to the analog voltage they represent, and the listener hears the original program, since the voltages we are talking about are of course, audio signals.

The reason for bothering with this analog/digital and digital/analog conversion process is that the digital data can be stored and retrieved with greater accuracy (and expense) than the equivalent audio, or analog, information. Since the digital information is a function of the audio signal only, noise within the transmission medium—tape hiss and all that—does not get converted into audio at the output end.

#### ECHO AND REVERB SYSTEMS

Following Dr. Blesser, Mahlon Burkhard of Industrial Research Products, Inc. discussed the specific application of digital technology to echo and reverberation systems. In either application, the audio signal is converted to digital pulses, which are stored in a memory system and reconverted to audio after a suitable delay. Although well suited for the creation of an audio echo or two, an orderly repetition of many delays,  $t$ ,  $2t$ ,  $3t$ ,  $4t$ , . . . may not sound altogether convincing as a simulation of reverberation. Natural reverberation consists of an incredibly large number of echoes, occurring at apparently random time intervals and at differing amplitudes. As Mr. Burkhard pointed out, a digital simulation of natural reverberation is still a costly process. However, there may come a time when the natural reverberation of an auditorium may be measured and artificially reproduced with digital techniques and at a realistic price tag. But not today.

#### DIGITAL FILTERING

Next, Thomas Curtis of Bell Telephone Laboratories spoke about digital filtering of audio signals. Or at least I think he did, but the math was way over my head, and I got lost almost at once. I think the point is that once the information is in digital form, it can be extensively modified before being converted back to analog audio. Earlier, Dr. Blesser alluded to various signal processing techniques that might be used digitally. Of course, neither conventional filters nor limiters will be usable in the digital world, so we may expect to see a new generation of devices presumably offering great flexibility at a very high price—at least at first.

Lexicon's Francis Lee demonstrated digital techniques applied to frequency shifting. Over the years, there have been many attempts at independently varying the frequency or timing of a program. Radio stations in particular would love a gadget that would allow them to speed up the last few minutes of a long running program, without raising the pitch. However, such devices still need a bit more development work. Speech remains intelligible, but music does not do well at all. Mr. Lee successfully demonstrated real time frequency shifting of his



voice, as well as time compression and expansion of previously recorded material.

During the afternoon session, Thomas Stockham of the University of Utah had originally planned to compare 24th generation digital and analog recordings. However, by the 17th generation, the analog recording had just about self-destructed, while the 24th digital was still of master quality. The conference's analog tape recorder, on which the final generations had been recorded for comparison, got a little temperamental—frightened perhaps at its prospects for future survival. However, the conference committee managed to get it back in shape in time for Mr. Stockham to make his point on the viability of digital recording, editing, and duplication.

Derek Tilsley, from the Neve home office in England, gave us a behind-the-scenes glimpse of his company's research work with digital technology. Neve engineers seem to be on the left side of fanaticism when it comes to noise figures, and haven't been satisfied with current automated mixdown techniques.

Towards the end of the conference, Motorola's Scalatron was described and demonstrated. The Scalatron, a digitally programable keyboard instrument, may be quickly tuned to any scale with up to 24 steps per octave. For more traditional tastes, the Scalatron may be tuned to say, a just tempered scale, to hear how it all sounded before Bach. And, transpositions can be worked out with little pain.

#### COMPUTER-GENERATED MUSIC

In the final presentation, Joseph Olive of Bell Telephone Labs discussed computer-generated music. Mr. Olive has been quite active in the area of computer music, and brought along several examples of his work.

One of the limitations of some computer-generated music is that the feedback loop between man and machine is broken. The composer must prepare his computer program, which the machines will digest. Some time later, out comes the music. Spontaneity of expression and phrasing is lost—pretty much like on a vocal overdub session—unless the computer works in real time, which may not be possible when complex sounds are required.

Mr. Olive demonstrated some interesting effects, such as the tone that seems to be continuously falling in frequency, without actually doing so. (If you weren't there, don't ask me to explain it).

The grand finale was an excerpt from an opera for soprano and computer. Our scientist-soprano begins teaching the computer to speak. After

a while, she tires of the exercise and turns the machine off. Or at least she thinks she does. Too late! The computer has been romantically aroused, and declares its affection for the scientist. Due no doubt to its digital heart, the computer's readout has determined that the scientist is a woman as well as a person. And she has discovered that it is a man as well as a machine. (I wonder what women's lib will do with this one?)

In a rousing duet that sounds suspiciously like the Brindisi from *La Traviata*, our hero and heroine pledge eternal devotion and other non-technical stuff. Perhaps their first genera-

tion reproduction will combine the best of analog and digital techniques. But that's another opera.

#### DEPARTMENT OF CORRECTIONS

For many years, the April sync track has been an april fool put on, as some very perceptive readers may have suspected. But last April's wasn't, except for one line that told about current going from water pipes to a.c. receptacle, via the grounding wire!! I wouldn't recommend that anybody try this very unique method, and if you'll just cross out the word "current," I hope the sentence will make better sense. ■

# A MARK OF QUALITY

#### ON THE FOLLOWING PRODUCTS:

- Studio condenser microphones and accessories
- Complete tape-to-disk mastering systems
- Custom studio mixing consoles



For your local representative contact:  
AUDIO EXPORT / GEORG NEUMANN & CO.  
71 HEILBRONN/NECKAR FLEINERSTR. 29  
POSTFACH 1180  
Phone: 8 22 75 Telex: 728 558  
Cable: AUDIOEXPORT HEILBRONN

Circle 24 on Reader Service Card

● A question that has recurred through the years appeared in my mail again during the past month. This particular reader asks, "Why are good conventional hi-fi speakers unsuitable for musical instrument reproduction or public address work? What are the major differences among them?"

### ENVIRONMENTAL FACTORS

After having written that heading, I find that it covers more than the simple thought I had in mind when I set it down. I was thinking of the *listening* environment: what the place in which you listen contributes to what you hear. But it can also apply to how the same environment influences the way the loudspeakers installed in it reproduce their sound. So let us take those two influences separately.

### EFFECT ON LISTENER

We listen to sounds for much of the time, and perhaps criticize them, without realizing that our surroundings influence what we hear, quite considerably. If you doubt that, cast your mind back to some time when you may have been moving. After all the furniture and perhaps the carpeting had been removed from your living room, did you notice what a hollow sound the room seemed to have when you spoke in it? Quite unlike the room you had grown accustomed to while you were living in it.

You may have been less conscious that the family room, or the utility room sounded quite different as an environment, than your living room, until you made that observation. As you moved from room to room, the sounds you heard in each seemed quite normal for that room, so much so that you were unaware that the room contributed anything to those sounds.

This is true, in a different way, of auditoria. The natural reverberation of an auditorium is something you come to accept as natural for that building, although it would seem strange indeed, suddenly transplanted into your living room. So one factor in why systems have different requirements is the fact that you *expect* to hear different kinds of sound, in different environments.

### EFFECT ON LOUSPEAKERS

In previous articles and columns,

we have pointed out that different kinds of loudspeaker systems suit different kinds of rooms. In the well-furnished, more absorbent kind of room, loudspeakers with a wide, flat frequency response and uniform dispersion over the frequency range will sound good, giving what would be identified as high fidelity performance.

In the more reflective environment of a family room, a different type of loudspeaker system will sound good: one that utilizes the many reflecting surfaces to achieve the overall effect, rather than one for which multiple reflections would detract from the performance.

Either system, listened to in the environment that suits it, would sound good, be recognized as a high fidelity system. But now trade places. In the wrong environment, each system would cease to give the same impression of high fidelity. This proves that loudspeakers sound different, according to the environment you put them in.

### PROGRAM FACTORS

Within limits, I suppose you can listen to any kind of program in any kind of environment—a pop concert in a church, or a symphony orchestra in a football stadium. This kind of thought again links back to the environment. But considering kinds of program also links to how you expect each kind to sound. You would not expect a full concert organ to sound like a harpsichord (although it may have a synthetic harpsichord as a feature). Nor would you expect a harpsichord to sound like a concert organ!

Accordingly, loudspeakers designed to reproduce an electronic organ, or an electronic harpsichord, will do their job best if each complements the instrument it is intended to reproduce. Similarly, a loudspeaker for use with an electric bass needs plenty of good, boomy bass and very little in the treble range. But if your symphony orchestra came out sounding like an electric bass, you would not like it too well, would you?

As opposed to that situation, where the loudspeaker will serve more effectively if its characteristics are similar to the instrument it is to reproduce, a high fidelity loudspeaker should have no character of its own. It should reproduce faithfully, whatever kind of sound is being fed to it

at the moment. This is a far more rigorous requirement than will be expected of a unit that will be called on to reproduce just one kind of instrument.

And what about public address work? Doesn't that have to meet similar demands to those made of a high fidelity loudspeaker? In the sense that, in some public address installations, the loudspeaker has to handle a wide variety of program types, one might imagine so. But it has to handle those varied programs in a totally different environment from that met by the high fidelity loudspeaker.

The high fidelity loudspeaker operates in a relatively intimate environment—a living room, or a family room—and even those are different, as we have seen. In such an intimate environment, our hearing faculty is at its most critical. But the public address loudspeaker has to play its part in a much more public environment.

Because of the sheer size of such public places, the listening faculty of the auditors is much less critical, although they may not be conscious of the difference. We have met more than one enthusiast for a public address installation who thought the loudspeakers presented were the ultimate in fidelity, sounding better than his hi-fi set, in his own living room.

### HEARING IS BELIEVING?

The old saying, "Seeing is believing," has been exploited through the centuries by sleight-of-hand artists who delude us with their magic acts. Under those circumstances, we know we are being fooled even if we don't know how. We may be aware that we can be fooled under other circumstances, but we are more reluctant to accept the fact that we may have been.

The same is true of the faculty that involves sound. Perhaps the most convincing demonstration of this that I remember concerns the first really high power loudspeaker unit I ever heard. I had been on vacation from the company that was developing it—a unit to handle 500 watts of sound, at an efficiency of better than 50 percent. That means it was capable of putting out more than 250 acoustic watts.

Most "high efficiency" units, even



today, seldom reach 20 percent efficiency. So that unit was really putting out a lot of power. I had left for my vacation while it was being built. When I returned, I thought I heard a sound car making announcements in the next street from my home. I wondered who it was, so drove around to see. No sound car. The sound must be coming from the next street over.

No sound car there, either. I kept going, toward the sound, until I found it. The company was testing the new unit, more than a mile from my home. In those days, London still had trolley cars, which made a noise that had always drowned the sound of loudspeakers.

I got right up to within a few feet of the loudspeaker, and remember being impressed with the fact that it did not seem all that loud. It happened that I was standing listening to it, on the opposite side of a street where the trolleys ran. Presently a trolley came by, and that was when I could not believe my ears. I could hardly hear the usual noise of the trolley: it did not interrupt my hearing of the sound at all, even when the trolley came between me and the loudspeaker!

In those days, a 5-watt speaker was fairly loud, and it would be fairly high efficiency at 5 percent, which would mean it delivered 250 milliwatts of acoustical power. When you think in watts, 250 watts is a thousand times as much as 250 milliwatts. But when you put that in dB, it is only 30 dB higher in level. And our hearing faculty can accommodate about a 120 dB range of levels. That explained it. But the experience proved it!

### ROCK SOUND

So what makes modern rock groups seem so loud? Of course, the fact that they perform indoors, where reverberation builds up the energy, makes the situation a little different from the experience I just related, where sound could go on expanding for miles. And speaking of that, the fact that the sound did not seem appreciably louder as I moved from block to block nearer to its source was due to the fact that a block is only a fraction of a mile. The level only raised a dB or so for each block I got nearer.

But the bigger cause for difference is the fact that rock people always operate their system up where it runs into distortion. It is the presence of distortion that really makes it seem loud, not the power they have.

This explains why these rock groups keep demanding more power and never seem satisfied. In their minds, 200 watts should be twice as loud as

100 watts. Then 500 watts should be 2½ times as loud as 200 watts. And 1000 watts would be twice as loud as 500 watts. Actually, those steps in loudness are only 3 dB, 4 dB and 3 dB, respectively. What gives the impression is not how many watts you have, although more watts will make it seem a little louder.

What really makes the rock groups loud, is the fact that they run into however many percent distortion—sometimes nearly 100 percent. As we mature, we find distortion unpleasant. It jangles our nerves, not much less when a 10 watt amplifier is run into high distortion, than when a 1000

watt amplifier is used. The latter is just 20 dB louder.

Try keying 20 dB of attenuation, in and out. The difference, admittedly, is quite noticeable. For that matter, 10 dB is noticeable. But 2 or 3 dB requires careful listening, to tell the difference. Isn't it time we started giving our young people an education in physics that told them some of these single facts of life, because if they would suffer their extra "loudness" at 10 or 20 dB lower, it might get the resultant sound below the threshold of hearing, a block or so away, where we might happen to be! ■

# A MARK OF QUALITY

## ON THE FOLLOWING PRODUCTS:

- "Magnetophon" M 12 professional ¼" tape recorders
- "Magnetophon" M 15 master tape recorders up to 24-tracks on 2" width tape



Outside the U.S.A. and Canada contact:

**AEG-TELEFUNKEN**  
Department "Magnetophon"

D-7750 Konstanz, West Germany  
P. O. Box 2154 Cables: telefunken konstanz  
Telex: 733233 Phone: (07531) 862495

Circle 25 on Reader Service Card

● In the April issue, this column discussed the AAAS convention and the concurrent exhibit which took place at the Lincoln Center Library in New York City. In that video exhibit, the first cameras functioning without vidicons were on display. We briefly indicated that miniaturization had come to the camera as a result of a new development, the CCD or charge-coupled device. This made the solid-state video camera truly solid-state, with not even the vidicon to contend with. Let's take a look at how these new tubeless wonders work.

### HISTORY OF TELEVISION

First, a peek at the chronology that led up to this momentous new position in the video field. Back in 1873, the light sensitivity of selenium was discovered. Just two years later, the first electronic television system was demonstrated. It could only detect and transmit the presence and absence of light, but this was the first time moving images were transmitted electronically. The method used to detect light was an array of 100 (10 x 10) selenium photo-cells.

In 1880, a principle for scanning was devised, and in 1884 the first camera using the rotating disc principle for scanning was developed. The method was to have a single spiral around the center. As the disc revolved, each hole closer to the center scanned a line lower on the subject. For a scan of 60 lines, it was necessary to have 60 holes. Equally spaced holes delivered equally spaced scan lines.

The next step came in 1897 when the cold cathode ray tube with magnetic deflections and fluorescent screen was demonstrated. Although a system of television using the CRT for both transmitter and receiver was first proposed in 1911, it wasn't until 1923 that the system was actually patented using the first electronic camera tube, the iconoscope.

Then, in 1940, the recommendations of the National Television Standards Committee for a television standard in this country was accepted by the FCC, and the NTSC system we use today came into existence. After that, most equipment and systems were designed around this standard for compatibility.

The next two steps made possible

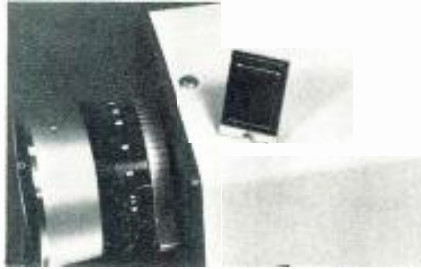

"Eye" on a Tubeless TV Camera.

the development of the closed circuit television systems used in non-broadcast applications. In 1947, the first transistor was developed and the solid state of electronics was born, and just three years later the vidicon came into existence.

Next came the introduction of the charge-coupled device in early 1970, but it wasn't until this year that the camera was introduced which made use of an array in a general fashion similar to the one demonstrated exactly 100 years ago this year! Generally, the CCD will find application in fields making use of memory circuitry and analog delay, but most rapidly in the imaging area, the one with which we are most interested here.

### CHARGE-COUPLED DEVICE

A CCD, requiring technology similar to that for producing other silicon devices such as the mos, is a wafer of a particular type of silicon covered by an oxide layer. Metallic electrodes are deposited on the layer. By charging the electrodes positively, electrons will collect at them selectively according to the intensity of the positive charge. By transferring the positive charge from electrode to electrode, the packets of electrons can be made to transfer accordingly. If an electrode were charged negatively, this would prevent the electrons from moving in the wrong direction and assure proper transfer. This, in essence, is the way the CCD functions.

In the case of the imaging device, the charge is introduced according to the light pattern of the subject picked by the device. Different methods can be used to collect the electron packets for conversion to impulses for transmission of the images. In the *frame transfer method*, for example,

the entire device consists of three vertical layers, with common horizontal electrodes. During a frame period, the light hits the first layer and electron bundles are formed. During the vertical retrace time, the entire array is pulsed and the electrons are transferred to the middle layer, in time for another frame to begin forming.

The second layer stores the "image" and feeds it on in sequence and at a specific time. During a horizontal retrace blanking period, the bottom line in "B" layer is fed to "C" layer and then one element at a time horizontally to the video output diode and amplifiers. These signals then modulate the beam in the display system to recreate the image. It can be seen that the more elements used in the CCD, the higher the resolution of the image. However, for practicality, there are certain limitations to the array arrangement. To provide broadcast quality, it might be necessary to have an array of somewhere near 500 x 500. If color were included, this would require, at present, triple such arrangement. To achieve requirements according to the NTSC RS-170 standard, RCA uses an array of 512 x 320 elements in the three-layer configuration.

This setup was arrived at by complying with the mathematical dictates of the standard. Considering the need for a 525-line scan, the 2:1 interlace requirement, the limitation of the usual closed circuit systems to 3 MHz in the luminance bandwidth, and the aspect ratio of 4:3, the 512 x 320 configuration can be calculated. Extra elements are included to account for variations in system blanking and timing and to provide greater uniformity around the edges of the picture.

### RCA'S BIG SID

The CCD utilized by RCA is considered to be the biggest of its kind presently in use. Since they named their unit SID (Silicon Imaging Device), they actually call it Big SID. With its over 1,633,000 elements, the resolution is higher than other similar units. In order to drive SID, a custom cmos has been developed which provides all the proper voltages and waveforms, takes the place of 35 conventional i.c.'s, and is already capable of driving three Big SIDs when color systems are introduced. (Incidentally,



SID, at just under 1.5 in. in length, is 100 times greater in area than the conventional i.c., and has electrodes so small that eight of them are equivalent to a human hair.) It is estimated that the CCD applications will grow \$300 million a year in the next ten years. SID will obviously be around for a while.

RCA is offering two grades of SID. For critical applications, a unit will cost \$2,300. Where budget is primary, the cost will be \$1,500 for the lower grade device. The primary difference "is with regard to the stringency of blemish screening criteria." Delivery of SID (and the two cameras being offered which include this device) is expected to be in the second quarter of this year. It is anticipated that the cost of devices similar to SID will be available around 1980 for about \$30.

#### SOLID-STATE CAMERAS

The cameras (Models TC1150 and TC1155) are black/white units and can be purchased with either of the SIDs. With the higher priced device, the camera will cost \$3,800, and with the lower grade one it will be \$3,000. The TC1150 comes with a built-in lens, adjustable from 14mm to 45mm, with automatic light control, 1v p-p composite output (BNC connector), weighs 2.5 lbs., and is less than 6 in. long and less than 3 in. high. The TC1155 comes with a standard "C" mount to allow for choice of lens, and has a greater sensitivity to permit operation in lower light levels.

Another camera using the solid-state technology is Model Z7892 by General Electric. It uses a charge-injection device (CID) sensor. It contains 244 rows of 188 elements each, and is also capable of providing an output compatible with standard t.v. systems. The camera has a "C" mount and comes with a 25mm, f-1.4 lens. An optional lens system is available which provides automatic light compensation.

The smallest camera of this type is the Fairchild mv-101. This unit is 3 in. in diameter and only 1 7/8 in. long. It weighs 11 oz. It uses a charge-coupled device with 10,000 photo-sensors. It has a "C" mount, comes with a 25mm lens, and provides a 2V p-p output. The vertical scan rate is 123 frames/sec. with 2:1 interlace, however, and since this does not conform to standard t.v. receivers, a special monitor is provided to accept the camera's output signal.

It's interesting to note that since the sensor used is responsive in the infra-red region of the light spectrum, it is suggested that the camera's performance is maximized in incandes-

cent lighting and will operate satisfactorily in the 0.2 foot-candle range. With fluorescent lighting, minimum levels will run about two foot-candles. (Incidentally, although the camera plugs in to standard power, it operates on 15V and its consumption is only 1.5 watts.)

#### ADVANTAGES

The advantages of the new technology in the video camera are that the CCD avoids the lag that is common with the vidicon during the object movement, it does not bloom, eliminates vidicon replacement due to defects of breakage, face spots or

burnout, is extremely low powered in operation, and avoids the need for critical alignment, necessary with vidicons in color applications.

As a final note on cameras, the world's smallest camera was introduced last April. It is a vidicon-type, using a tube only 0.5 in. in diameter (made by British EMI). The camera (produced by Reten Electronic of W. Germany) is 0.75 in diameter and 5.5 in. long.

It looks as if we have passed Buck Rogers by a long shot. Now all we have to do is to catch up to Dick Tracy. Wristwatch t.v. camera-receivers may not be far off after all. ■

# A MARK OF QUALITY

ON THE  
FOLLOWING  
PRODUCTS:



Telefunken and Neumann are also exclusively represented by Gotham in Canada.



Sold and serviced exclusively  
in the United States

**GOTHAM**  
AUDIO CORPORATION

741 Washington Street, New York, NY 10014  
(Tel: 212-741-7411)  
1710 N. La Brea Ave., Hollywood, CA 90046  
(Tel: 213-874-4444)

**RADFORD**

## Audio Measuring Instruments

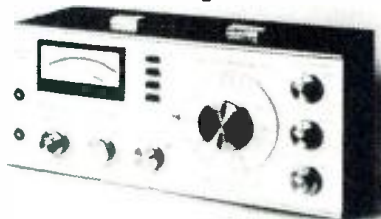

### Low Distortion Oscillator Series 3

A continuously variable frequency laboratory oscillator with a range of 10Hz-100kHz, having virtually zero distortion over the audio frequency band with a fast settling time.

#### SPECIFICATIONS:

Frequency range: 10Hz-100kHz (4 bands)  
Output voltage: 10 volts r.m.s. max.

Output source resistance: 150 ohms  
unbalanced (plus 150/600 balanced/  
floating)

Output attenuation: 0-100dB (eight,  
10dB steps plus 0-20dB variable)

Output attenuation accuracy: 1%  
Sine wave distortion: Less than 0.002%  
10Hz-10kHz (typically below noise  
of measuring instrument)

Square wave rise and fall time: 40/60  
n.secs.

Monitor output meter: Scaled 0-3, 0-10  
and dBV.

Mains input: 110V/130V, 220V/240V  
Size: 17" (43cm) x 7" (18cm) high x  
8 3/4" (22cm) deep

Price: 150 ohms unbalanced output:  
\$950.00.  
150/600 unbalanced/balanced floating  
output: \$1070.00.

### Distortion Measuring Set Series 3

A sensitive instrument with high input impedance for the measurement of total harmonic distortion. Designed for speedy and accurate use. Capable of measuring distortion products down to 0.001%. Direct reading from calibrated meter scale.

#### SPECIFICATIONS:

Frequency range: 5Hz-50kHz (4 bands)  
Distortion range (f.s.d.): 0.01%-100%  
(9 ranges)

Input voltage measurement range:  
50mv-60V (3 ranges)

Input resistance: 47Kohms on all ranges  
High pass filter: 12dB/octave below  
500Hz

Power requirement: 2 x PP9, included  
Size: 17" (43cm) x 7" (18cm) high x  
8 3/4" (22cm) deep

Price: \$770.00

## AUDIONICS

10035 NE Sandy Blvd.  
Portland, Oregon 97220

Authorized U.S. Sales Agency for  
Radford Laboratory Instruments

MARTIN DICKSTEIN

## Laserium...Light With Music

*A fusion of music and the incredible colors produced  
by the laser—a different entertainment experience.*

AS YOU APPROACH the entrance to the Hayden Planetarium, there is a crowd waiting to go in to see Laserium. Most of the visitors have already purchased their tickets from Ticketron, but some will form a line in hopes that this performance is not a sell-out. Maybe there will be some tickets still available at the box office.

A few minutes before the program is to begin, the audience is allowed to go upstairs and find seats in the dimly lit circular amphitheater under the planetarium dome. In the center, stands the Zeiss star projector. There is music, and there is a feeling of excitement and anticipation which always seems to be engendered in the domed room, with its mysterious access to the universe.

A member of the Planetarium staff welcomes the audience (right on time) and explains briefly that the show will take place on the dome overhead, that the images will be produced by a laser (which is completely safe, should anyone wonder) operated by a laserist who will create the program completely live. Brian Bassett, the operator of the laser console is introduced, and the lights begin to dim. The stars come out and the skyline of New York can be seen around the horizon.

As the music begins, the lights fade out completely and the room is in total darkness except for the stars overhead. (The audience reacts vocally with surprise and pleasure at the beauty of the scene.) The music swells and the stars begin to move as they normally do. The skyline has disappeared and the tension builds.

*Martin Dickstein is well known to readers of db. Special thanks to Ron Bassett, Brian Bassett, and Michael Gershman of Laser Images, Inc.*



1. Composite photo showing a laser pattern above the dome of the Griffith Observatory in Los Angeles.

A cloud begins to appear, seemingly in space—not really on the dome. It moves gently, changes form and color, increases in size and follows the quiet serene music. The colors are bright, very bright, and again the audience reacts with pleasure. As the music flows, so do the clouds. The music ends and the clouds vanish. The stars, which have been a background to the entire selection, continue to move.

#### VARYING SELECTIONS

The next selection begins. The music builds in rising pitch. Wild images follow the music—this portion of the show is totally different from the first. The selections follow in this manner—some slow and gentle, some rock music, some contemporary music. Each is different from any of the others, and the images on the dome take form in movement and shape as the laserist feels the music.

During the selections, the audience reacts to the images and the rhythm. There is laughter, applause, "oohs"



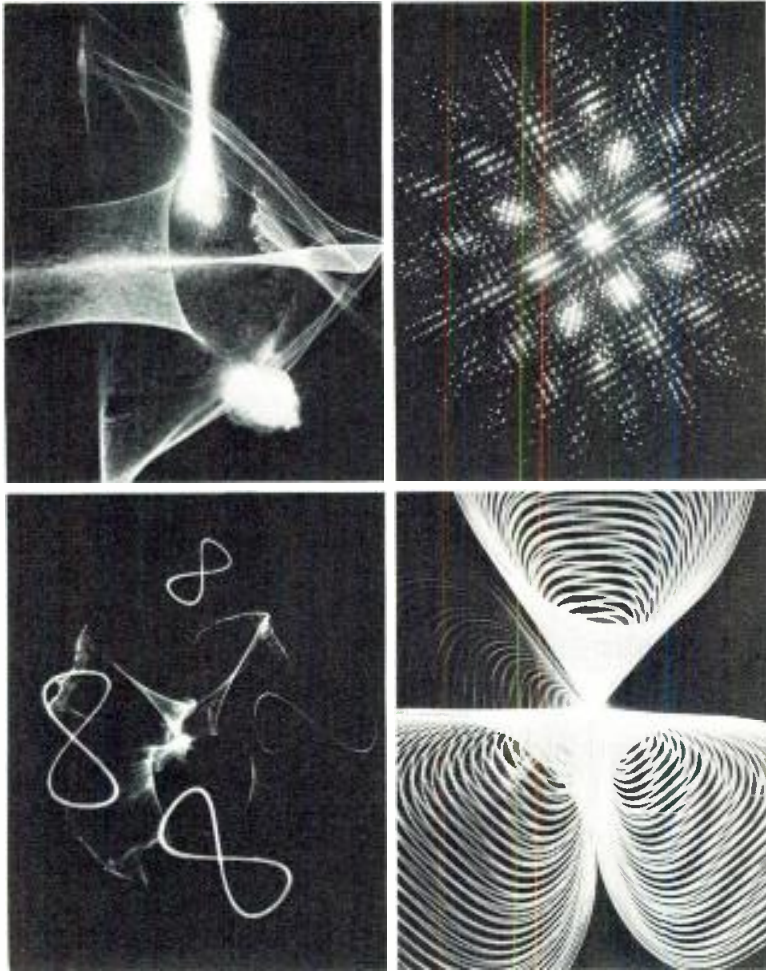

2. Typical laser light patterns, stimulated by music.

and "ahs," and a big round of applause at the conclusion of each portion of the show. A creative bond between the laserist and the audience grows; one senses this sharing in the increased vigor of the performer. He sets up the patterns and shapes with the pushbuttons, controls size with rotary knobs, and moves the images around the roof with the joy-stick control which permits slow glides or quick leaps of any of the figures he has built up. He knows each note of the music, and the musical group seems to follow each move he makes (or is it the other way around?).

The music begins with *Fanfare for the Common Man* by Copeland, includes *The Planets* by Holst and *The Blue Danube* by Strauss, as well as a selection from *Clockwork Orange*, then changes completely in texture and rhythm and driving power with *Tank* and *Abaddon's Bolero* by Emerson, Lake and Palmer and *Space Race* by Preston. *The Pines of Rome* completes the performance. The multi-colored clouds, vibrating shapes, and undulating patterns diminish as the music ceases, soften, and end the show quietly.

When the audience has finally left, after asking all kinds of questions of the laserist and the operator of the star projector, the star projector is again positioned to show the stars as they appear in the New York sky on the date of the presentation. The laser system is again set up with mirrors and beam splitters in proper positions for the first musical selection. The tape is recued. The power supply is checked, the console buttons and controls are put in proper position. The laserist, really the star of the show (besides the overhead display) takes a break and collects his energies for the next show.

#### LASERIUM—HOW DID IT ALL BEGIN?

*Laser*—a word coined a little over 10 years ago to describe a newly invented device . . . has since become a household word.

*Laserium*—a word devised just a few years ago as a name for a new application for the laser and a novel human experience . . . soon to become a household word!

The laser came into being in 1960 and got its name from the method by



the new standard in  
**professional  
audio design**

### amplifiers



**DX, TAX  
SERIES  
70 TO 250  
WATTS RMS**

**INCOMPARABLE** solid-state amplifiers for continuous-duty performance, available in a broad selection to meet professional audio amplification requirements.

### mixer-amplifiers



**SPECTRUM  
SERIES  
40, 80, 120  
WATTS RMS**

**SUPERIOR** mixer-amplifiers with less than 1.5% THD and program equalization provisions. Flexible, advanced design; professional in every sense of the word—for the most demanding applications.

### input equipment



**4907 R  
PREAMP  
  
4908  
MIXER-  
EXPANDER**

**OPTIMUM** mixing performance in maximum flexibility input equipment. Ideal for broadcast and recording use, theaters, auditoriums, and churches. Distinguished for ultra-low distortion and wide-range performance.

### for equalization



**6101  
SPECTRUM  
MASTER**

**PRECISE** professional acoustical analysis and system correction in minimum time is now at your command with this all-new 1/2 Octave Active Filter Test and Correction Instrument-System.

WRITE FOR TECHNICAL BULLETINS

**RAULAND-BORG CORPORATION**

3535 W. Addison St., Dept. N, Chicago, Ill. 60618

Circle 28 on Reader Service Card



**We take the wait out of erasing lots of tape**



New Model 70 cleanly erases any 7" reel, cartridge, or cassette in one pass over the continuous belt. Your tapes will be as clean as new in 4 seconds. For audio, video, and data tapes.



**GARNER INDUSTRIES**  
4200 North 48th Street, Lincoln, Nebraska 68504

Circle 29 on Reader Service Card

which it gives off its light—Light Amplification by Stimulated Emission of Radiation. A laser makes use of the principal of physics that energy is emitted when outer electrons of specific atoms move from one energy level to another in the right direction. Part of that energy is in the visible frequency range, and light results. The color of the light is determined by the wavelength of the energy. By stimulating this emission of radiation, amplifying it, and projecting the beam, the laser has been made to do what it does best, project an intense light.

Lasers can be made with a solid, liquid or gas medium in a tube with highly reflective spherical mirrors at both ends. Gas lasers emit continuous light and have been found most satisfactory for work with three colors. Once the energy is released by use of either an electric charge or rf frequencies, the light particles are pulsed to travel between the mirrors until they are released through a tiny "window" at one end of the tube. Output energy is about 1 percent of the total in the tube.

The light from a laser is very unique, and differs greatly from ordinary light. When the sun or any kind of light bulb gives off light, it radiates equally in all directions and the

beams are non-coherent. The laser emits a beam which is coherent, extremely narrow (a half-inch at the tube spreads to a diameter of only about 3 inches in a mile) and the frequency band is also extremely narrow for the emitted rays, resulting in the brightest and sharpest colors ever seen. Nevertheless, the power required for a laser can be very small. These factors make the laser a natural for a Laserium presentation.

### THE LASER IN ACTION

The laser has found application in medicine and surgery (eye operations without incision, for example), space measurement (checking distance from earth to moon to within inches from reflectors left by the moon-walkers), industry (checking for microscopic defects in parts and machines) and even as a potential weapon, mentioned often in science fiction. (It can burn a hole, when concentrated, through solid steel.)

Experimentation has been going on in the creation of holograms and 3-D motion pictures. Extensive use was made of the laser in the Pepsi Cola Pavilion at Expo '70 in Osaka, Japan, for environmental displays. But for the first time in public entertainment, in the Laserium display, the laser, with music, makes possible the whole show.

Laser Images, Inc. of Van Nuys, California, was incorporated in early 1971 "primarily to engage in the use of lasers for design and theatrical purposes, including, but not limited to the production of designs, photographs, films, light shows, and light show devices." After several commissions to create films for motion pictures and television, experimentation led to the most dramatic form of laser imagery—Laserium. L.I.I. is still experimenting, considering offers for new shows for various institutions and

# What would you expect an IMA to do?



- Perform SMPTE intermodulation analyses quickly and easily, even in the millivolt range?
  - Measure amplifier noise?
  - Measure transistor noise?
- Evaluate magnetic tape drop-out?
- Test oscillator amplitude stability?
- Measure tape recording distortion?
- Evaluate phono stylus wear and tracking?
  - Test electromechanical transducers for intermodulation?

*The Crown IMA does all of it. Internal intermodulation distortion is less than 0.005%. Write us for more complete information and application notes.*

 **crown** INTERNATIONAL  
1718 W. MISHAWAKA ROAD ELKHART, INDIANA 46514 219-294-5571

Circle 30 on Reader Service Card

● It is with deep personal regret that we report the death, on April 13, of **Herman H. Scott**, founder and former president of **H. H. Scott, Inc.** of Maynard, Mass. Mr. Scott was the inventor of the dynamic noise suppressor, R-C oscillator, and selective circuits. He received the Distinguished Service Award from President Kennedy's Committee on the Employment of the Physically Handicapped.

Mr. Scott was a development and executive engineer with the **General Radio Corporation** from 1931 to 1946, president of the **Technological Instrument Corporation** in 1946-7. He founded **H. H. Scott, Inc.** in 1947 and retired in 1972.



a rock group, and planning further installations of the Laserium presentation.

### LASERIUM

Laserium, emphasis on the second syllable, is a word derived from "laser," and "planetarium," the location where the shows take place. It played its first show under the dome of the Griffith Observatory in Los Angeles and is still running there.

In New York, the show began its performances in October, 1974 at the American Museum of Natural History, Hayden Planetarium. Images, created in four colors—red, blue, green and yellow are cast on the 81-foot dome by a 1 watt laser, in association with music. Each performance has the same music, but the visual aspects of every show are totally different. Each presentation is unique, a one-and-only done live by a laserist, who operates a console with illuminated pushbuttons, rotary controls, and a joy-stick. The rack next to him houses the laser, its power supply, and the water cooling system (35 degrees C maximum) to keep the laser's temperature at its normal level. The rack also holds the 4-track audio tape recorder which provides the music for the show and some control cues. (Total system, costs about \$100,000.)

The laser itself is approximately 4 ft. long and 6 in. wide and weighs 50 lbs. (It costs approximately \$10,000, according to Spectra-Physics of Mountain View, California, who made this unit.) Although similar models are made with argon or argon/krypton, this one is made with krypton. The beams of light, with special optics, and front surface mirrors (with 50 coatings) can be projected onto the ceiling in dots (only about 4 in. in diameter) expanded to circles to almost the diameter of the dome, take the shape of geometric figures, or become nebulous clouds which seemingly float in open space.

Shapes change, positions vary slowly and smoothly or in bursts and jumps. Sizes, also controlled to follow the music, can change gently or very rapidly. Every change is made manually by the laserist, with only a very few exceptions which are controlled by the tape cues.

The sound portion of the presentation comes from two of the four tracks on the tape. Stereo music plays through two Crown dual 300-watt amplifiers and is distributed by four Altec A-7 speakers located behind (actually above) the perforated dome. There are also six surround speakers in the amphitheater for fuller sound and special effects. (This equipment is part of the Planetarium's regular sound system.)

Laserium really must be seen and heard to be believed. The programs are presented on Friday, Saturday and Sunday evenings. Since the first showing less than two years ago, over a quarter of a million people have come and experienced the shows in various cities. About 50,000 of them have come to the display at the Hayden. There are also showings at the Gates Planetarium in Denver, the Morrison in San Francisco, the Reuben H. Fleet Space Theater in San Diego (and the Griffith in Los Angeles, of course). There is now a traveling show (with a screen instead of

a dome) going to colleges across the country. All installations seem to be doing well and will continue indefinitely.

Make Laserium a part of your enjoyment this summer—wherever you are. Experience! Enjoy! ■

### IT'S A SMALL WORLD!

#### SMALLER AUDIO TRANSFORMERS

Sizes: 1-3/8" x 1-15/16", 15/16" x 1-1/4", 9/16" x 5/8" (Send for complete catalog)



Quality Engineered Sound Products  
SESCOM, INC.  
P. O. Box 590, Gardena, CA 90247 U.S.A.  
(213) 770-3510 • TWX 910-346-7023

Circle 31 on Reader Service Card

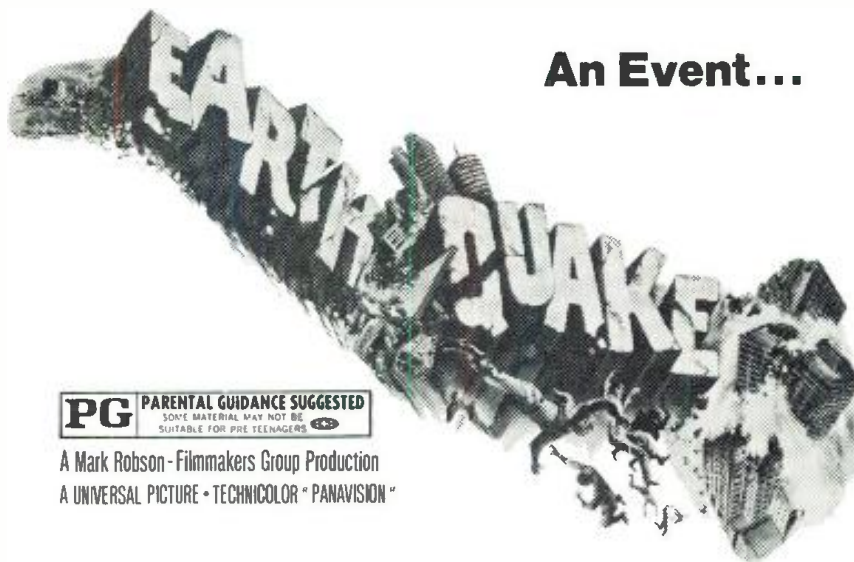

## An Event...

**PG** PARENTAL GUIDANCE SUGGESTED  
SOME MATERIAL MAY NOT BE  
SUITABLE FOR PRE-TEENAGERS

A Mark Robson-Filmmakers Group Production  
A UNIVERSAL PICTURE • TECHNICOLOR • PANAVISION

## SHOOK YOU USING BGW POWER AMPLIFIERS

Universal Studios' professional sound experts consider BGW amplifiers reliable, safe and powerful enough for their great new movie sensation.



Hundreds of BGW Model 750A's have been installed in theaters around the world for

**SENSURROUND™**

This same amplifier will create unbelievable sound in your system.



BGW Systems  
P.O. Box 3742  
Beverly Hills  
CA 90212  
(213) 391-0320

BGW has five other power amps and two studio quality preamplifiers making BGW the critics' choice.

Circle 32 on Reader Service Card

# db new products & services

## FREQUENCY SHIFTER

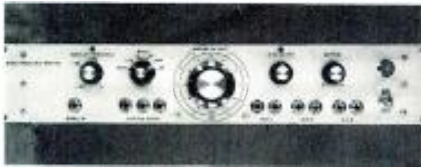

● New sounds are created by model 735 frequency shifter through a change in the harmonic structure of any natural or synthesized sound received at the input. The device creates shifts by as much as +5 kHz through zero to -5 kHz (and simultaneously the inverse) through turning of a master dial. Three pairs of output jacks provide the up and down shifted signals, as well as a variable mixture of both. The amount of frequency shift is voltage controllable in a linear as well as exponential mode. In the exponential mode, the device is compatible with keyboard controllers of synthesizers. In the quiescent state, a threshold-sensitive squelch circuit eliminates any carrier feedthrough. Frequency response is 30 Hz to 16 kHz. Comes on a 19 in. rack mount.

*Mfr: Bode Sound Co.*

*Price: \$995.00.*

*Circle 50 on Reader Service Card*

## TWO-TRACK MASTERING RECORDER



● A switchable playback head and 10½-inch reel adaptors are featured in model A-6100, a ½-track recorder with four heads, one of which is a ¼-track playback head that is switchable on the head bridge. The three motors are powered with a hysteresis synchronous capstan drive. The dual-functioning metering system, consisting of two vu meters to indicate average levels and two peak reading led's to indicate transients allows the user to record 3 dB hotter when using high-energy tape. There is also a pad for 15 dB or 30 dB of attenuation. High-density heads have a flip-up hinged head cover. The unit has two-position bias and eq. switches, and microswitch pushbutton transport con-

trol. Cue control allows cueing in either the fast wind or pause modes and for manual reel rotation during editing. There is an automatic stop function from the rewind mode and a zero vu click stop on the output level control. Adaptors automatically compensate for the height difference between 7-inch and 10½-inch reels.

*Mfr: TEAC*

*Price: \$999.50*

*Circle 51 on Reader Service Card*

## BACKGROUND MUSIC SYSTEM



● Background music system TRAK-4, utilizing two playback decks, can provide music that will intersperse with commercial announcements, or play two musical formats. This is done by interfacing two TRAK-4 playback units and a mixer switch. The system is also capable of playing 32 hours of music before repeating. The unit is a continuous-duty type of machine with built-in amplification, microphone input, volume and tone controls. The 16-hour tape magazine can be quickly loaded or unloaded without threading. The mixer switch may be set to play the two decks alternately or in a 3:1 sequence.

*Mfr: Tape-Athon Corp.*

*Circle 52 on Reader Service Card*

## DISCOTHEQUE CONSOLE



● Compact package system ATS DC-202, designed for the confines of discotheque use, offers the following: stereo operation; auxiliary stereo input; complete cueing system with volume presents; program send to cue buss; separate hi and low EQ. on program and mic channels; built-in 30 watt cue amplifier with speakers and headphone output; gooseneck d.j.

microphone with built-in variable echo; footswitch operation of microphone. Clearly visible vu meters enable the operator to keep track of proceedings. *Mfr: Audio Transport Systems*  
*Circle 53 on Reader Service Card*

## PORTABLE PARABOLIC REFLECTOR

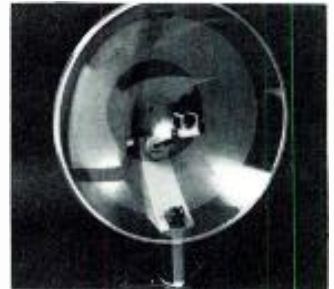

● Depending on climatic conditions and surroundings, PBR-400 parabolic reflector can pick up high quality sound from a distance of up to several hundred yards. The manufacturer claims that the PBR-400 will improve the sound sensitivity of most omnidirectional microphones 10 to 20 dB over rated sensitivity. Angle of acceptance is approximately 26 degrees. The unit, weighing less than three pounds, is hand operable or can be used on a tripod. Included with the reflector are a microphone stand adaptor, tripod stand adaptor, and carrying case.

*Mfr: Superscope (Sony)*

*Price: \$79.95.*

*Circle 54 on Reader Service Card*

## CUE CLOCK



● "Cue Clock" is an up/down digital timer which counts up to or down from any thumbwheel preset time; a cue light shows the end of count. A "set" light indicates that the unit is programmed and ready. The clock, which operates manually or through remote control, has a timing capacity up to 99 min. 59 sec. It uses TTL logic throughout, with a seven-segment display. The clock starts automatically when any switched voltage is applied, without relays. Data outputs are provided for custom interfacing with automation systems.

*Mfr: Electroneering, Inc.*

*Circle 55 on Reader Service Card*



# THE PEAVEY 1200 MIXER



In response to the market demand, we present the 1200 Mixer, the first truly professional mixer for less than \$1,000.

- 12 transformer balanced, low impedance mike inputs
  - 12 unbalanced, high impedance line inputs
  - Input attenuation & mike/line selection
  - High and low equalization on each channel
  - Stereo pan on each channel
- Three send controls on each channel, all having pre or post capability
  - Output slide attenuators on each channel
- Master control area consisting of left & right main slide attenuators with associated low, middle & high equalization and monitor slide attenuator.
  - Effects master, return & pan controls
  - Reverb master, return, & pan controls
- 600 Ohm transformer balanced outputs on left & right main and monitor
  - Lighted VU meter on left & right mains, externally adjustable.

Suggested Retail Price

**\$949.50**



FOR MORE ABOUT THE 1200 MIXER WRITE: PEAVEY ELECTRONICS, BOX 2898, MERIDIAN, MS . 39301

Circle 33 on Reader Service Card



# AT LAST!

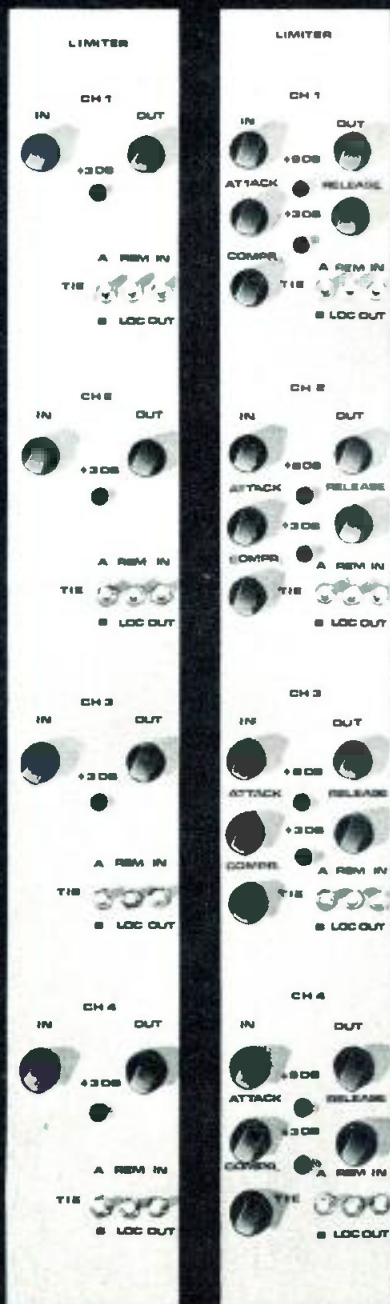

L-100T

L-150T

4-channel limiters  
for TASCAM consoles  
(compatible in  
price and design)

manufactured by

**sound genesis**  
INCORPORATED

445 Byrant Street  
San Francisco, CA 94107  
Telephone 415/391-8776  
a TASCAM dealer



Circle 34 on Reader Service Card

## new products & services (cont.) INSTANT FLANGER

### HIGH VOLTAGE PROBE FOR TV



● Self-contained, direct reading, high voltage and current measuring probe model HVP-5 provides for the safe measurements of voltage up to 40,000 volts d.c., and for separate current measurements up to 200 mA d.c. It measures accurately the high anode voltage of a color picture tube and, through the use of a switch monitor, the cathode current drawn by the horizontal output tube or the output stage. The two circuits are completely separate, enabling the technician to switch from the mA position to the HV position without disrupting the operation of the set under test.

Mfr: *EICO Electronic Instrument Co.*  
Price: \$29.95.

Circle 56 on Reader Service Card

### SERVO FEEDBACK SPEAKER SYSTEM



● The servo system controlling the SmartSpeaker line utilizes a sensing network that compares the mechanical analog of the speaker output with the applied electrical inputs and then generates a correcting voltage. This voltage is fed back to the amplifier to adjust the input to the speaker's voice coil and thereby compensate for errors normally introduced by conventional loudspeakers. Other benefits claimed include improved transient response, reduced phase distortion, and increased dynamic range. The line consists of three models, model 15, a floor-standing three-way system, model 12, a large bookshelf unit, and smaller bookshelf system model 10.

Mfr: *C/M Audio Components*  
Circle 57 on Reader Service Card



● An effect modifier block on Instant Flanger™ model FL201 allows "bounce" circuit to simulate true tape flanging by imitating motor or servo hunting. Depth control regulates the percentage of direct vs. delayed signal, and relative phase. Other features include internal regulated power supply, remote control capability, dual outputs for pseudo-stereo, internal envelope follower, line in/out control and indicator, high level input and output, optional balanced line in/out, full frequency response to 15 kHz, automatic operation with oscillator, mode indicating lamps. The control configuration—oscillator, manual, remote—envelope may be used in any combination. The Instant Flanger uses a true time delay circuit, which the manufacturer claims will produce many more nulls and thus a deeper effect than previously available with an all-electronic unit. Construction is all solid-state, with i.e.d. front panel indicators. Internal circuit boards plug in.

Mfr: *Eventide Clockworks*

Circle 58 on Reader Service Card

### PRECISION SOUND-LEVEL METER



● The capability to "hold and display" the maximum level measured on a digital display while an analog meter continues to indicate lower levels is a feature of the model 1981 sound-level meter. The meter features both a digital display and a large, linear analog meter, meets ANSI S1A and IEC 179 specifications, and has a measurement range of 70 to 120 dBA. The analog scale spans the entire 70 to 120 dBA range linearly in 1dB increments. While measuring, either fast or slow detector response may be selected. The unit is available alone or in sets or systems.

Mfr: *General Radio*

Circle 59 on Reader Service Card



a special offer for **db** readers!

A MUST  
FOR  
ANYONE  
INTERESTED  
IN THE  
MUSIC  
INDUSTRY—

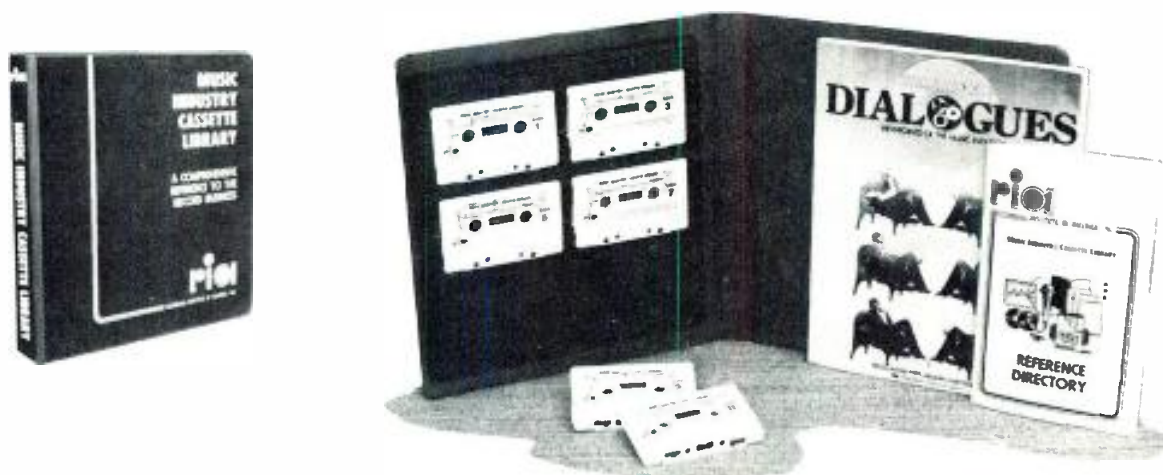

# Learn The Business - of Our Business!

Compiled from Recording Institute of America's interviews with key executives and "hit-makers", plus Reference Directory and Dialogue's Viewpoints of industry "stars".

Listen to the industry "pros" describe the workings of the Music Business. Hear the most respected attorneys of the entertainment field define and discuss the legal terminology of Recording Contracts, Songwriter Contracts, Professional Management Contracts. Over 3½ hours of professional reference... could be the most important 200 minutes of your life!

Plus... RIA Reference Directory, including sample songwriter affiliation forms, sample artist contracts, writer contracts, etc., in addition to a Directory of Record Manufacturers, Music Publishers, Personal Managers, Producers and Booking Agents. Also Record World's "Dialogues" with over 50 candid interviews from Record World magazine, and a cross-section of "star" personality interviews.

You get all the above (regularly \$49.95) for only \$39.95 for db readers.

**\*Interviews include:**

Pete Bennett	Promotion, Apple Records
Sid Bernstein	Personal Manager and Promoter
Rick Blackburn	Dir. of Sales, Columbia Records
Terry Cashman	Pres., Cashwest Productions, Inc.
Bob Cato	V.P., Creative Services, United Artists
Kip Cohen	V.P., A&R, A&M Records
Al Coury	V.P., Production, Capitol Records
Al DeMarino	V.P., Music Department, CMA
Tom Draper	Dir., R&B, RCA Records
Kenny Gamble	Pres. & Producer, Phila Int Rec Co
David Glew	V.P., Marketing, Atlantic Records
Barbara Harris	Dir. Artist Relations, Atlantic Records
Emil LaViola	Prod. Mgt., Chappell Publishers
Michael Martineau	Booking Agent, Premier Talent
Mark Meyerson	A&R, Atlantic Records
Barry Oslander	West Coast Prof. Dir., Jobete Music Co
Richard H. Roemer	Law Firm of Roemer & Nadler
Alvin Teller	V.P. Merchandising Marketing, Columbia Records
Peter Thall	Law Firm of Casper & Thall, P.C.
Ron Weisner	V.P. Artist Relations, Buddah Records

... and many others

**ORDER FORM — MAIL TODAY**

Sagamore Publishing Co., Inc.  
1120 Old Country Road, Plainview, N.Y. 11803

Please send [ ] copies of " **MUSIC INDUSTRY CASSETTE LIBRARY** " at \$39.95 each.

*Please Print*

Name \_\_\_\_\_

Address \_\_\_\_\_

City \_\_\_\_\_ State \_\_\_\_\_ Zip \_\_\_\_\_

Total Amount \$ \_\_\_\_\_ Check/Money Order for \$ \_\_\_\_\_

10 Day Money Back Guarantee

**db**

db June 1975 23

**CARTRIDGE TAPE SPLICE FINDER**



● 240 volt/50 Hz automatic cartridge tape splice finder and bulk eraser, model SFE-3, has been developed to cut broadcast cartridge handling time by automatically locating a splice on a cartridge and kicking out the cartridge with the tape stopped just beyond the splice point, without the need for human surveillance. Recording begins immediately after the splice, precluding the possibility of an audible blip. The pressure-sensitive device does not require a prerecorded signal. It will also detect tape fractures and exercise the tapes for better performance. An optional built-in bulk eraser allows cartridges to be erased and searched on the same machine.  
 Mfr: UMC Electronics Co.  
 Circle 60 on Reader Service Card



● Model 8004 turntable features gyro-poise® frictionless magnetic suspension of the platter and single point tone arm suspension. Powered by a 24-pole synchronous high torque motor, it has belt drive. The tone arm has a magnetic hold bar and anti-skate control adaptable to all types of styli. The turntable is equipped with a state-of-the-art cartridge, either the 681 triple-E calibrated to the tone arm for stereo playback or 780/4DQ for discrete.  
 Mfr: Stanton Magnetics  
 Price: Stereo: \$199.95  
 4-channel: \$224.95.  
 Circle 61 on Reader Service Card

fixed or scientific notation; and perform conventional arithmetical functions with the contents of its single addressable memory. Since several keys serve multi-functions, the number of operations possible has been compressed into a small size. The device, which operates on two rechargeable batteries, features an RPN logic system with a four-memory stack that holds intermediate answers and automatically brings them back when needed in calculation.  
 Mfr: Hewlett-Packard  
 Price: \$125.00.  
 Circle 62 on Reader Service Card

**FUNCTION GENERATOR**



● Available in either kit or assembled form, model 1271 function generator generates sine, square or triangle waveforms from 0.1 Hz to 1 mHz. A short-circuit-proof output amplifier supplies a 10-volt peak-to-peak signal into a 50-ohm load. A calibrated step attenuator adjusts from zero to 50dB (10V p-p/30mV p-p) in 10 dB steps. 20 dB additional attenuation for each step for a total of 70 dB is achieved through the variable attenuator control. The manufacturer claims attenuator accuracy is  $\pm 1$  dB.  
 Mfr: Heath Company  
 Price: Kit: \$99.95  
 Assembled: \$140.00.  
 Circle 63 on Reader Service Card

**ENGINEERING CALCULATOR**



● Trigonometric and logarithmic functions are handled by 6-ounce HP-21 scientific calculator. In addition, the user can calculate in either degrees or radians; convert from polar to rectangular coordinates and vice versa; format and round the display in either

**CHEAP**  
 —but not dirty

60 Watts—4.0 or 8.0 Ohms minimum sine wave continuous average power from 20 Hz to 20 kHz with less than .05% total harmonic distortion.

Our power amplifiers are some of the best available. Our prices are some of the most reasonable available. You may not be familiar with our products since we sell only by direct mail and don't advertise a great deal.

We would like to send you our new 1975 catalog showing all of our fine audio products and test report information on our famous "Tiger .01" shown above. You might be pleasantly surprised at how little clean power actually costs.

#207 Complete Kit.....\$ 77.50 Ppd  
 #207-A Assembled Amplifier...\$110.00 Ppd

**Southwest Technical Products**  
 219 W. Rhapsody  
 San Antonio, Texas 78216

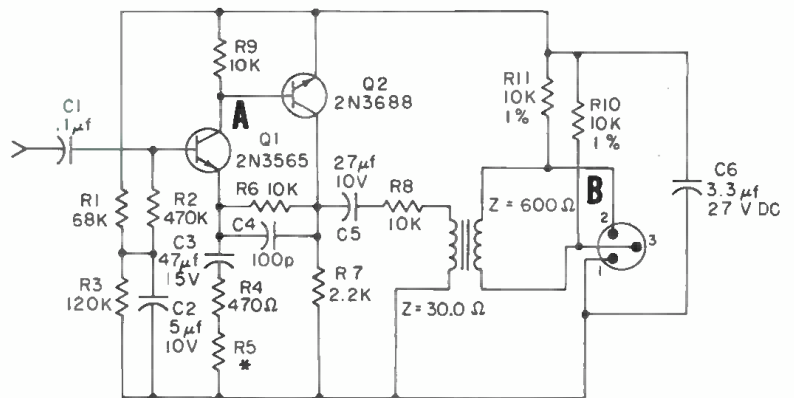

\* GAIN ADJUST  
 MAX 10K  
 MIN 0Ω

**CORRECTION**

In the above direct-box diagram (which appeared in db, April 1975, p. 18) the circuitry at two points, A and B, was incomplete. The circuitry shown here is correct.



# INSTALL IT AND FORGET IT!

## WE BUILD AND TEST EACH AMPLIFIER WITH THE CONVICTION THAT WE'LL NEVER SEE IT AGAIN

That's why 25% of our people work in inspection and verification. And we have this confidence in our amplifiers because our people make sure you receive a better amplifier than you ordered. You'll find the Crown line of power amplifiers unique in both specifications and operation. And that kind of confidence you can pass on to your clients.

Output Power: 30 watts per channel minimum RMS (both channels operating) into an 8 ohm load over a bandwidth of 35 Hz—15 KHz at a rated RMS sum total harmonic distortion of 0.05%.  
Dimensions: 19" wide by 8¾" deep by 1¾" high.  
Weight: 10 lbs.



The Crown D-60 stereo amplifier, small in size, big in value and adaptability. Its uses include headphone power supply for system monitoring; ideal power for high-efficiency speakers; can be easily used in bi-amping and tri-amping situations and can be field modified to produce 25 volt monaural output power for industrial sound distribution systems.

Output Power: 75 watts per channel minimum RMS (both channels operating) into an 8 ohm load over a bandwidth of 1 Hz—20 KHz at a rated RMS sum total harmonic distortion of 0.05%.  
Dimensions: 17" wide by 8¾" deep by 5¼" high.  
Weight: 24 lbs.



The D-150 medium power amplifier, is by design an ideal audio amplifier with the kind of rugged reliability needed in portable sound systems. Especially where one to one amp/speaker ratios are used. Well known Crown protection circuits are an integral part of the D-150. Protection from mismatched or shorted loads is provided, and a series limiting resistor protects against excessive input signals. Controlled slewing-rate voltage amplifiers protect against RF burnouts. And a thermal switch cuts AC line power if overheating occurs from improper ventilation.

Output Power: 155 watts per channel minimum RMS (both channels operating) into an 8 ohm load over a bandwidth of 1 Hz—20 KHz at a rated RMS sum total harmonic distortion of 0.05%.  
Dimensions: 19" wide by 9¾" deep by 7" high.  
Weight: 45 lbs.



The Crown DC-300A. High power is first thought of when referring to a "super" amplifier. However, this Crown amplifier is also super in its reliability; super in its capability to deliver sound without distortion, and super in its ability to power any type of load, from 2.5 to 16 ohms, resistive or reactive! And whether it powers a multi-speaker theatre system or is on line with a group of twenty or thirty DC-300A's for an outdoor rock session, this amplifier delivers 100%. And we know that in whatever application you use it, the DC-300A will give you the kind of reliability you're looking for.

Output Power: 600 watts minimum RMS into an 8 ohms load over a bandwidth of 1 Hz—20 KHz at a rated RMS sum total harmonic distortion of 0.05%.  
Dimensions: 19" wide by 16½" deep by 8¾" high.  
Weight: 92 lbs.



The Crown M-600 power amplifier was designed specifically for applications requiring relatively high power levels. The M-600 maintains all the exacting Crown laboratory performance standards, plus featuring built-in cooling for continuous full power operation.

The M-600 also features Crown's patented protection circuitry allowing it to drive highly reactive and low impedance loads without adverse effects. A newly patented output bridge circuit permits extremely high power levels to be sustained safely.

If by this time you do not have enough power to do the job, consider the M-2000, DC-1200 or the DC-4000. These configurations are combinations of the M-600 and are specifically designed for applications where huge amounts of power (2 kilowatts plus) are needed.

Crown amps are widely known for superior performance and reliability, and like every Crown product are covered by a comprehensive warranty which includes parts, labor and round-trip shipping for three years.



Circle 40 on Reader Service Card



Jim Nielsen at the console at Freeway Recording.



Wally Heider's Studio C, just completed, set for a John Coaltrane album.

STEPHEN H. LAMPEN

# How Audio Is Doing In San Francisco

*Major recording studios seem to be holding their own, with many garage-types doing a lot of budget work. Manufacturers feel the pinch of tight money.*

**H**ARD TIMES have hit all sections of the audio industry. But, in the San Francisco area at least, the response to a tightening money situation and a drop in customers has been most unorthodox: Build now!

Among the ten 16- or 24-track recording studios surveyed, seven were in the process of expanding or improving their facilities. "It was a question of expanding while we still had the money and fewer customers to bother, or waiting until it was too late," I was told. Still, all admitted that the hectic, profitable days of the late sixties when the Grateful Dead, the Jefferson Airplane and Santana dominated the rock industry are gone now and may never return. At that time, some studios were booked a year or more in advance. Now, a week's notice—or less in some cases—is all that's necessary. And, while two large studios have folded in the last couple of years, neither termination was due to the present financial conditions. Perhaps cur-

rent circumstances now can be best described as solidification.

## TIGHT MONEY EVERYWHERE

The same cannot be said of the manufacturers, however, to whom tight money means strangulation. Almost all manufacturers who were around five years ago are still here, but the picture still looks grim for some. I was told of one major manufacturer's chief executive appearing before the stockholders in makeup, to indicate subconsciously that the company was as healthy as his ruddy appearance. Don't know if it worked!

Distributors and representatives are a quick-moving, fast-talking breed, almost impossible to keep track of over the years. Over thirty pro dealers cover the Bay Area with practically every line of recording, broadcasting, duplication, and public-address equipment. Some are borderline-pro, offering what could easily be called good hi-fi equipment but also selling to small studios and independent producers who cannot afford major studio prices.

Thereby hangs another change in the sound scene: the tremendous rise in the number of studios-in-garages. Any estimates as to their number would be difficult because





*Record Plant's psychedelic Studio B.*



*The cutting room at Fantasy Records.*

many do not advertise for customers. But there must certainly be over a hundred of them cranking out marginally acceptable quality programs for budget labels or broadcast.

### **FREEWAY RECORDING**

Minorities and women were not very much in evidence in any of the studios visited, the one exception being Freeway Recording in Oakland, which is owned by Bernie Reveira. Because of his minority status, he received a substantial SBA loan to start his studio and other ventures. From what we saw, the money was spent intelligently. A custom Opamp board feeds their 3M 16-track machine which can be mixed to two 3M 2-trackers. A dbx 216 noise-reduction system is used.

Other support equipment includes UREI 527A graphic equalizers and 1176 limiters, Spectrasonics 610 complimitters, McIntosh and Crown power amps. Besides the Altec 604E's which almost every studio offers, Freeway had a double-pair of Quad electrostatics. While clean, and even with the surprising low-end which a pair produces, they lack the power-handling abilities of standard speaker designs such as the Altecs. When we visited, they were just completing the installation of the studio and were looking forward to major business in the near future.

### **WALLY HEIDER'S**

Wally Heider's, in San Francisco, is a different story. Although not the oldest studio in the city, they are one of the first which come to mind because of their work with the rock stars of the last ten years, turning out one

million-seller after another. Studio C, upstairs, had just been completed and, even with plaster still on the floor, was set up for Van Coaltrane, who was doing some work later in the day. Hot Tuna was also in the building in Studio D. All studios, in fact, most of the Heider chain, standardize their equipment: Dimidio custom board, modified by Miter Productions; 3M 24- or 16-track recorder; 3M 2-track machines; Altec 604E monitors; McIntosh 275 amps; UREI LA3A and 1176 limiters; Dolby 361As in one room; APL 550 EQs on all board inputs in Studio C; Pultec PEQ-2 equalizers. Studio A had a Quad-8 board modified to 24-channel use and also had the Altec 891A mini monitors for limited range mixes.

### **RECORD PLANT**

Meanwhile, Record Plant in Sausalito, the "beautiful" studio in the Bay Area, is also expanding its facility. In keeping with its "subdued freak" decor, the new studio, dubbed The Pit, will be recording-in-the-round—with a twist!

"Where's the console going to go?" I asked the secretary.

"Why, right here," she said pointing to a large opening in the circle of what will be plush seating.

"What about recorders?" I continued.

"Over here," she indicated, pointing to smaller gaps in the seating.

"Well then," I asked, "where's the studio if this is the control room?"

"This *is* the studio," she insisted.



*Sierra Sound's recorders.*



*Everything's portable at His Master's Wheels, even the Neve console.*



Engineer & producer working on commercial at *Different Fur*.



Columbia's cutting room. Their patchbay is the largest the author has seen.

At this point I gave up. But I can't wait until it's finished and I get to see what they did. These two existing studios, often the hangout of Sly and the Family Stone, are plush-plush-plush designed with the richer labels in mind by Westlake Audio. API boards feed 3M 24-track and 2-track machines, with extra Ampex 2-tracks, and 4-tracks. Dolby M-16 or M-16-8X units provide noise reduction with UREI LA3A and 1176 limiters, Eventide phasers, Pultec equalizers, Cooper Time Cube, United Audio's Little Dipper and Westlake monitors filling out the scene.

I strolled among the studios. "And this," continued my guide, pointing to a deep fold in the tapestry wall, "is where Sly puts his baby when he's recording." I look puzzled. She continued. "They put a mic on the kid and, every so often, the engineer hits the solo button to see if the little one is crying." A customer breakthrough: nursery service!

In the other direction, down the peninsula, we find Pacific Recording finishing up Studio 2. The main studio is supplied with an Ampex MM-1000-16, 2 Ampex MR-70-2, and 440-1, all fed from a custom board. The Grateful Dead cut their first hits here.

**SIERRA SOUND**

Across the bay in Berkeley, Sierra Sound is working hard with mixing TV tracks for the Serendipity Singers, many gospel groups and some commercials. Sierra will be re-worked completely this year, owner-chief engineer Bob de Sousa told me. "We can't stay in business without doing it. Customers require absolute separation." Quite a tall order, I would think, and if he succeeds, I want to know who the architect was.

**FANTASY RECORDS**

Only a few minutes away from Sierra lies the massive concrete blockhouse of Fantasy Records. I was amazed to see a customer actually turned away! I asked why, and manager Jim Stern's reply was, "We do only in-house production; we don't need any outside business."

With three well-equipped studios—Studio A had just been completed—they must have a solid core of return customers. He assured me they did. Still, in spite of their entry hall lined with all the Gold Records earned by Creedence Clearwater Revival, times have calmed down for them as well. This is the only concern in the Bay Area that does recording, cutting, record promotion, and distribution under one roof. All they're missing is a pressing plant of their own, something Mr. Stern said they were not planning on establishing. Farming out the work worked fine. Studio A, one of the largest rooms in the area, had

been re-fitted for film scoring, complete with Magnatec mag-film machines and complete projection equipment. The film version of "One Flew over the Cuckoo's Nest" was waiting to move in.

**HIS MASTER'S WHEELS**

One of the newest studios in the area is San Francisco's His Master's Wheels which, as the name suggests, does a lot of on-location recording. However, they also maintain a studio equipped with their totally removable gear. Everything is either carryable or on wheels. Part of a wall collapses to let their Neve console and two MM-1000-16 Ampex machines roll out and into the truck. They had just finished recording the Grateful Dead's last concerts, which I had photographed, by coincidence, and they were enmeshed in the re-mixing for record release and for the feature film which had been shot.

The studio, the best acoustically I found in my survey, has a skylight—but no outside leakage. Still can't figure out how they did it. Their equipment also features Studer A-80-2 and Ampex 351-2 machines, the latter modified with MCI electronics, Phase Linear amps feeding JBL or Klipsch monitors, Pultec equalizers, Eventide phaser, Multi-Track equalizers and UREI graphic equalizers.

**DIFFERENT FUR**

Not far away lay Different Fur, a small, but prospering studio, also in San Francisco. Pat Gleason told me they had just had their 12th consecutive quarter of growth. With their custom-built Spectrasonics console, Scully 100-16- and 4-track, they could offer pro quality at a competitive price. But, the outlook was not that good, Mr. Gleason emphasized. "There's less business coming in the near future for all studios, but we're not going in for price cutting. Any studio would be crazy to cost cut now. It's better to compete on service. There's no sense to lose money working full-time."

**COLUMBIA-COAST**

The San Francisco scene is rounded out with the two oldest studios in the area: the Coast-Columbia complex and Golden State Recorders. Coast and Columbia both seem to represent the conservative aspects of the industry; they don't have the latest gadgets—just the best. No doubt part of the reason for this is that as part of the Columbia chain, all equipment changes must be authorized through the head office. Even I had to be cleared through the head office! Still, being under a mother's wing has its advantages in hard times.

All artists on the Columbia and related labels use the



studio so that one has, in effect, a built-in clientele. Equipment available includes two Ampex MM-1000-16- with an EECO synchronizer for 30-track recording if required, 4 digital delays, UREI LA3A limiters, and the largest patch bay I have ever seen. "We can patch anything to anything," Chief Engineer George Horn told me. There are also Pultec equalizers, RCA limiters, Ampex 440-4 and 440-2 machines and monitoring on Altec 9845 speakers modified with J.B.L. 2420 drivers. A custom 38-in console feeds the system with rotary switching which can bring any track from any machine up on any fader. Versatility, right?

The next room, Studio B, was busy with the mix for Michael Schreve's new album, (Schreve is late of Santana.) Across the hall, Coast Recorders, a smaller studio, held the last vestige from the umbrella days of a few years ago: a large beach parasol over the drum set. They had a 3M 8-track and Ampex 300-4, 440-2, 300-1 machines. Down the hall, the Columbia master room held their Scully lathe with Westrex 3D-2 cutter and 440 Ampex playback machine.

### GOLDEN STATE

And then we have Golden State, where hits they produced in the early fifties are still on the walls. This is also the home of the College for Recording Arts, the only recording school in the area. Both are ably run by Leo deGar Kulka, who, at first glance, looks sure to throw you out for the slightest infringement, but who turns out to be one of the nicest people I met on my journeys. With their Stephens 16-track, custom board and an ancient (but rock-solid) Ampex 200 full-track complement, as well as Altec 604C monitors and support gear, they offer not only a well-equipped atmosphere but a good place to learn.

So, everyone seems to be surviving. In some cases, one might almost say, prospering. I still think of one of the defunct studios. I heard through the grapevine that the owner had to choose between his wife and the studio. Maybe he made the wrong choice. ■

## BAY AREA DIRECTORY

*As an aid to those working in the Bay Area we list herewith a directory of DISTRIBUTORS and REPRESENTATIVES that handle professional equipment. Also listed are MANUFACTURERS of pro-audio equipment. We have made every attempt to make this little directory as complete as possible, but since that seems to be an impossible feat, we will bring it up to date as soon as we receive the usual indignant "you-left-me-out" letters. Maybe we can blame it on our computer!*

### DISTRIBUTORS/REPRESENTATIVES:

#### All Area Code 415

#### DALY CITY:

QRI Corp. 465-1312  
Cetec  
Gauss

#### LAFAYETTE:

Wilkins-Mason Associates  
284-9200  
Acoustic Research  
Ampex Tape  
Phase Linear  
Koss

**MENLO PARK:**  
H&K Sales. 369-6244  
Sony  
Marantz

**OAKLAND:**  
General Electronics Systems, Inc.  
658-9490

Neumann  
Electro-Voice  
Sennheiser  
Turner  
Shure  
AKG  
Phillips  
Altec  
R-Columbia  
Memorex  
BASF  
3M Tape  
Switchcraft  
Rauland  
Fairchild  
Sony  
Atlas  
Argus  
Ampex  
Teac  
Tascam  
Vega

**Norleen Sound Service. 652-2631**

3M Tape  
Editall  
Electro-Voice  
Atlas

**Hank Gabriel. 465-5361**

Fairchild  
Sescom  
Telex/Magnecord  
University  
Eddor  
Mohawk

**Professional Audio Electronics**

654-6630  
Electro-Sound  
Electro-Voice  
Shure  
Klipsch  
Sony  
Crown  
Accuphase  
Thorens  
Soundcraftsman  
DBX  
Teac

**True Recordings. 652-8863**

Revox  
McIntosh  
Beyer  
AKG  
Crown  
Tandberg

**Paul Seaman Co. 562-9241**

Teac  
Tascam  
TDK  
Audio Technica  
Soundcraftsman  
Royal  
Accuphase

**Cass Electronics. 834-4225**

DBX  
Cetec  
Gauss  
Electro-Voice  
Shure  
Turner  
Audio Tape  
Audio Pak carts  
Switchcraft  
Dyna  
SAE  
Teac  
Telex  
Winlab

**Mike Stobin Co. 836-2937**

SAE  
ADS-Braun  
Hervic  
Winlab  
Grace  
Supex

**PALO ALTO:**

**Western Audio Imports. 321-0664**

Crown  
McIntosh  
Revox  
Sennheiser  
MB  
AKG  
Vega  
Sony  
Shure  
Lamb  
Teac  
Uher  
Tandberg  
Beyer

**REDWOOD CITY:**

**Accurate Sound. 365-2843**

AKG  
Ampex  
Audiotek  
Asco  
DBX  
Innovonics  
3M  
Revox  
Countryman  
Russco  
Stevenson  
Tascam  
Sennheiser  
JBL  
Audio Tape  
Electro-Sound  
Sony  
Parasound  
Shure  
Tascam  
UREI  
VIF  
JVC  
Switchcraft  
Marantz  
Nortronics  
Spectrasonics  
MRL  
Electro-Voice  
LPB  
Altec  
Cetec  
Crown  
Scully  
Nagra  
Otari  
Editall  
Neumann  
Telex  
Recortec  
Taber  
Liberty

**Magnetic Tape Distributors  
326-3540**

3M Tape

**The Woodworth Company**

365-0252  
Waters  
CMS

**SAN CARLOS:**

**Dobbs-Stanford. 592-5958**

Crown  
DBX  
Uher  
Yamaha  
Group 128  
Schweitzer  
Vaco-Rac

(continued)

# Neve

THE QUALITY MIXER

ON THE ROCKS

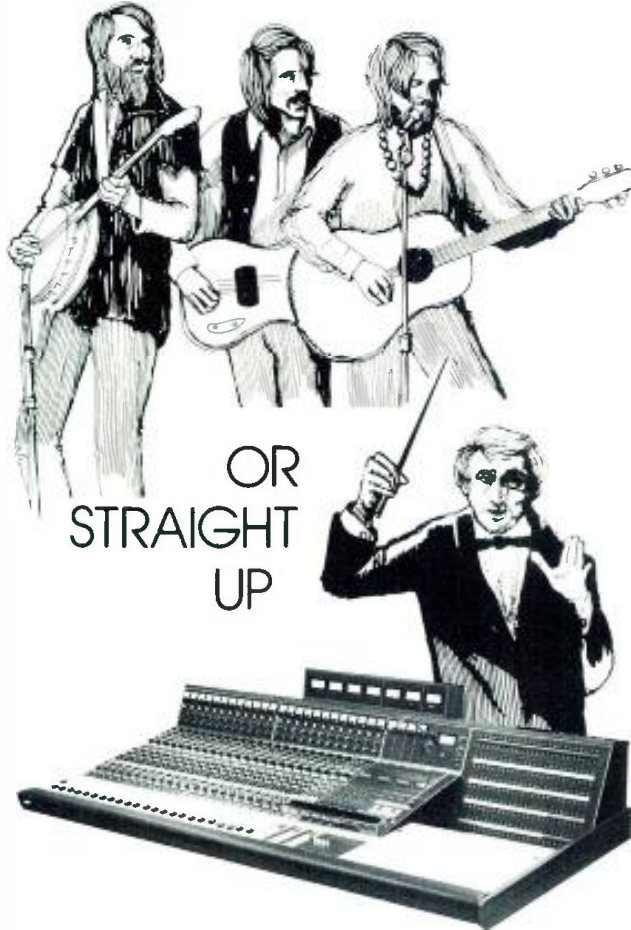

OR  
STRAIGHT  
UP

NEVE ANNOUNCES THE NEW 8024 CONSOLE. Where else can you get a 24 track recording and do simultaneous quad, stereo and mono mix downs?

This 24 track console provides all the flexibility one can imagine within the astonishing length 80.5 inches.

LOOK AT THE FEATURES — 24 In/24 Out • Overdub • 24 Track Monitoring • Full EQ on Every Channel • Simultaneous Quad, Stereo and Mono Mixers • Quad Positioning on Each Channel • And for Added Flexibility There are 240 Jacks.

Of course, the Neve quality is built into this console which is delivered with its own handbook, spares kit, and all mating XLR connectors, and you will be amazed at the low price. Couple this with the now famous Neve Service and you again have a winning combination. CALL US —

Rupert Neve Incorporated, Berkshire Industrial Park,  
Bethel, Connecticut 06801 Tel: (203) 744-6230. Telex: 969638  
Rupert Neve Incorporated, Suite 616.

1800 N. Highland Ave., Hollywood, California 90028 Tel: (213) 465-4822  
Rupert Neve of Canada, Ltd., 2717 Rena Road,  
Malton, Ontario L4T 3K1, Canada Tel: (416) 677-6611  
Rupert Neve & Company Ltd., Cambridge House,  
Melbourn, Royston, Hertfordshire, SG8 6AU England, Tel: (0763) 60776  
Rupert Neve GmbH, 6100 Darmstadt Bismarckstrasse  
114 West Germany, Tel: (06151) 81764

Circle 37 on Reader Service Card

**SAN LEANDRO:**  
Taber Manufacturing &  
Engineering. 635-3831

Ampeg  
Scully  
Electro-Sound  
Gotham  
Revox  
Tascam  
UREI  
STL  
Burwen  
Inovonics  
Electro-Voice  
AKG  
Russco  
Altec  
Wireless  
Vega  
Nortronics  
Cetec  
Teac  
University  
Soundoliere  
Telex  
Crown

Nagra  
Crown  
Atlas  
Electro-Voice  
Sony  
Stellavox  
D&M  
Uher  
AKG  
Teac  
Tapco  
Ampex  
Countryman

**Edisco. 756-0300**

Shure  
Atlas  
Lowell  
Nortronics  
Bogen  
Utah  
BASF  
Electro-Voice  
University  
Memorex

**Sound Genesis. 391-8776**

Advent  
Atlas  
Crown  
Electro-Voice  
Langevin  
Metrotec  
Ramko  
Scully  
Sony  
UREI  
AKG  
Ampex  
DBX  
MB  
Parasound  
Revox  
Sennheiser  
Soundcraftsmen  
Otari  
Allison  
Beyer  
Editall  
Gauss  
Maxell  
Scotch  
Russco  
Sescom  
Tascam  
Altec  
Countryman  
Electro-Sound  
JBL  
McIntosh  
Quad-8  
Scott Instruments  
Shure  
Teac

**SAN FRANCISCO:**

**McCune Sound. 777-2700**

Altec  
Jensen  
Atlas  
Vega  
Switchcraft  
Clear-Com  
Shure  
3M Tape  
Crown  
Toa  
Koss  
Electro-Voice  
AKG  
Eddor  
Telex  
Orrtronics

**Alembic Inc. 864-3800**

JBL  
Parasound

**Adolph Gasser Enterprises  
495-3852**

Nagra  
Stellavox  
Sony  
Arrivox  
Sennheiser  
Shure  
AKG  
Vega  
Electro-Voice

**San Francisco Radio: 863-6000**

Teac  
Shure  
Telex  
Koss  
Sony  
Sennheiser  
McIntosh  
Electro-Voice  
AKG  
Altec  
Thorens  
Bogen

**Brooks Camera. 392-1900**

Sony  
Marantz  
Uher  
Jensen  
Teac  
Acoustic Research

**Skinner Studios. 986-5040**

Sennheiser  
Shure  
Audio Devices

**Technical Sales Associates**

467-1434  
Oxford  
E-V/Game  
Permapower  
McMartin  
Fourjay

**Audio-Video Associates. 626-2038**

Lowell  
Sennheiser  
Frasier  
Belden  
Cornish  
Atlas  
Electro-Voice  
AKG  
Bogen  
Columbia  
Cannon  
Soundoliere  
Bozak  
Magnecord  
University  
Alpha  
Shure



**Lumiere Productions. 989-1130**

Altec  
Crown  
JBL  
Shure  
Atlas  
Electro-Voice  
McIntosh  
Stevenson  
Cerwin-Vega  
Community Light & Sound  
Sennheiser

**SAN MATEO:**

**Protronics Co. 574-8511**

Altec  
Teac  
Sennheiser  
Shure  
MB  
Ampex  
McIntosh  
Sony  
Electro-Voice  
UREI  
AKG  
Countryman  
Crown  
Neumann  
Quad-8  
Parasound  
Tascam  
Quantum  
Gately  
JBL  
ARP

**TERRA LINDA:**

**Catania Sound. 479-7043**

McIntosh  
Fisher  
Superscope  
Altec  
Teac  
Shure

B&O  
Kenwood  
ESS  
Thorens  
Tandberg  
Sherwood  
Marantz  
JBL  
Phillips  
Sony

**TIBURON:**

**Corporate Media Systems.**

**435-2020**

Altec  
Gauss  
Shure  
Telex  
Vega  
AKG  
McKenzie  
Sony  
Tape-A-Thon  
Wireless  
Ecor  
Marantz  
Spectrasonics  
UREI  
Fairchild  
Sennheiser  
Toa  
University

**WALNUT CREEK:**

**MacPherson Sales Corp.**

**937-1482**

Bose  
OEM  
Rotel  
AKG  
Vega  
Tapco  
Phillips  
Dather  
Innermedia

**MANUFACTURERS**

Alembic  
60 Brady St.  
San Francisco CA 94103  
864-3800  
Ampex  
401 Broadway  
Redwood City CA 94063  
367-2011  
Audio-Tek  
2970 Scott Blvd.  
Santa Clara CA 95050  
408-244-1776  
Electro-Sound  
725 Kifer Rd.  
Sunnyvale CA 94086  
408-245-6600  
Clear-Com  
759 Harrison St.  
San Francisco CA 94107  
415-989-1130  
Electronic Music Associated  
3400 Wyman St.  
Oakland CA 946159  
532-5034  
FRAP  
PO Box 40097  
San Francisco CA 94140  
824-2223  
Kinetic Technology  
3393 De La Cruz Blvd.  
Santa Clara CA 95050  
408-296-9305  
Memorex Corporation  
1200 Memorex Dr.  
Santa Clara CA 95052  
408-987-1325  
Parasound  
680 Beach St. #495  
San Francisco CA 94109  
776-2808

Recortec  
777 Palomar  
Sunnyvale CA 94086  
408-735-8821  
Sound Genesis  
445 Bryant  
San Francisco CA 94107  
391-8776  
Taber Manufacturing & Engrg.  
2081 Edison Ave.  
San Leandro CA 94577  
635-3831  
Tentel  
1210 Camden  
Campbell CA 95008  
408-377-6588  
Scully-Metrotech  
475 Ellis St.  
Mountain View CA 94040  
968-8389  
Countryman Associates  
424 University Ave.  
Palto Alto CA 94302  
326-6980  
MRL  
999 Commercial St.  
Palo Alto CA 94303  
327-6724

**BRANCH OFFICES:**

Agfa  
1 W. Mill Dr.  
Brisbane CA 94005  
B&K  
1611 Borel Pl. #236  
San Mateo CA  
CBS Laboratories  
1 Embarcadero Center  
San Francisco CA 94111  
3M Tape  
320 Shaw  
South San Francisco CA

**Why does Studio Tempo use the Amber Audio Spectrum Display?**

Studio Tempo uses an Amber Audio Spectrum Display in their Montreal recording studio. Michel Lachance, Chief Engineer, explains why:

"I use the display primarily during mixing to prevent problems later on in mastering. I constantly watch the display during a mix to ensure my tape does not have excessive high or low frequency energy. If I want to highlight a particular instrument I can see the effects of equalization or other forms of processing. The peak responding characteristics of the display give far more information about what's on a tape than a VU meter.

"One very handy thing I use the display for is verification of performance of equipment. I'm very particular about alignment, and I like to put a sweep tape on our 24 track before each session and read each track with the display. It shows exactly in dB any response errors and all 24 tracks can be checked in minutes".

See for yourself. Contact Amber for the name of a nearby dealer and arrange for a demonstration in your studio — it really works.

Amber model 4550 Audio Spectrum Display  
\$1,800 US List.

**AMBER ELECTRO DESIGN LTD**  
1064 CHEMIN DU GOLF  
MONTREAL QUEBEC CANADA  
H3E 1H4  
(514) 769 2739

**amber**

db June 1975

31

Circle 38 on Reader Service Card

# Covers Audio Band In One Sweep

*A 555 timer can be adapted to create a square-wave generator which covers the 20-20,000 Hz range in one sweep with no band switching.*

**S**OMETIMES, IN AUDIO WORK, it's handy to have a generator which covers the entire 20-20,000 Hz range in one sweep, with no band switching. The ubiquitous 555 timer can be adapted to this function, producing 50 percent duty cycle square waves whose frequency is controlled over a 1000:1 range by a single potentiometer.

The complete circuit is shown in FIGURE 1. Note two items: 1. The capacitor is charged and discharged by the output stage (pin 3), rather than the discharge transistor (pin 7) as is usually done. That simplifies the frequency control. 2. A symmetry resistor,  $R_s$ , goes from pin 5 to ground. This resistor adjusts the duty cycle and the proper value yields exactly 50 percent, as will be explained.

Recall that, for the connections shown in FIGURE 1, the maximum voltage on the capacitor is the same as that on pin 5 ( $V_5$ ), and the minimum is half that on pin 5 ( $\frac{1}{2}V_5$ ). If we assume that the low voltage from the output stage ( $V_{3L}$ ) is approximately zero and leave the high output voltage ( $V_{3H}$ ) temporarily unspecified, then the charging time for the capacitor is:

$$t_c = R_F C \ln \frac{V_{3H} - \frac{1}{2}V_5}{V_{3H} - V_5}$$

and the discharge time is:

$$t_d = R_F C \ln 2.$$

For 50 percent duty cycle,  $t_c = t_d$ , or  $V_5 = \frac{2}{3}V_{3H}$

Now if it were the case that  $V_{3H} = V_{cc}$ ,  $R_s$  would not be needed since the internal divider string puts pin 5 at  $\frac{2}{3}V_{cc}$ . But as the data sheets for the 555 show,  $V_{3H}$  is about 1.4 volts below  $V_{cc}$ . Using this value, the formula for  $R_s$  is

$$R_s = R \frac{V_5}{V_{cc} - 1.5V_5} = R(.476V_{cc} - .667)$$

where  $R$  is specified as 5000 ohms per resistor. For a 5-volt supply,  $R_s = 8.6k$  to give a symmetrical square wave.

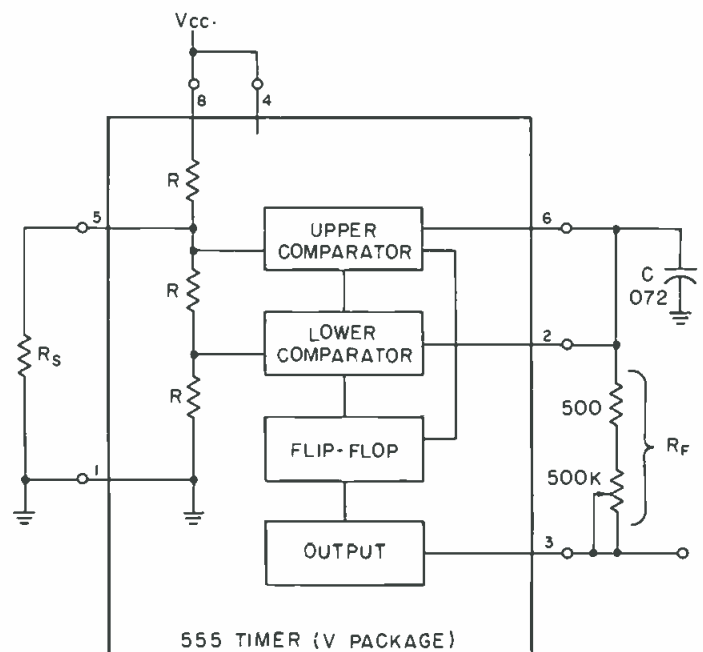

Figure 1. 20-20,000 Hz square-wave generator.

The frequency of oscillation, very simply, is

$$f = \frac{1}{t_c + t_d} = \frac{1}{2R_F C \ln 2} = \frac{.721}{R_F C}$$

If  $C = 0.0721$  uf,  $f = 10^7/R_F$ .

The frequency determining resistor,  $R_F$ , consists of a fixed part of 500 ohms and a variable part of 0.5 megohm. A log-taper audio volume control gives a much smoother distribution of frequencies with rotation than a linear taper would. For a proper sense of rotation, put the frequency calibration marks on a skirted dial rather than on the panel. (If that sounds puzzling, try it.) The 500-ohm fixed resistor sets the 20,000 Hz frequency. However, check the minimum resistance of the pot (terminals 1 and 2) and subtract this from the fixed resistor. ■

James J. Davidson is a consultant with Davidson Consultants, in Overland Park, Kansas.



# COMPARE

## ADM'S NRC and the "Usual" Consoles!



When you buy an Audio Designs NRC Console, you get a professionally engineered unit built to the highest quality standards. And you are assured of "no hassle" service assistance whenever you need it. But that's not all. You get extra performance and features not usually found in the ordinary console.

**Look at the "unusual" extras you get in ADM Consoles**

### ADM FULL-FEATURED CONSOLES

- AUDEX—solid state audio reed switching system..... not the "usual" troublesome push buttons.
- SLIDEX—noise-free linear attenuator with elements sealed against dirt..... not the "usual" open elements (noisy).
- VUE-Scan—bar graph TV screen for monitoring up to 28 audio channels, switchable between peak and average reading..... not the "usual" mess of meters.
- 4-band, 14 frequency reciprocal equalizer on all inputs..... not the "usual" 3-band.
- 4 sets of Machine Remotes..... not the "usual" one or none.
- Full quadrasonic capabilities with 4 joy sticks..... not the "usual" one or two joy sticks.
- Simultaneous multi-track (8, 16, 24 track), quad, stereo and mono outputs..... not the "usual" multi-purpose outputs.
- Complete tip, ring and sleeve patching..... not the "usual" miniature size or limited patching.
- 4 cue channels..... not the "usual" one or two.
- 2 solo systems..... not the "usual" one.
- 5-Year Warranty on parts and labor..... not the "usual" 90 days to one year.

Write or call collect for further information on the UNusual ADM Console.



AUDIO DESIGNS AND MANUFACTURING, INC.  
16005 Sturgeon  
Roseville, Michigan 48066  
Phone: (313) 778-8400, Cable: AUDEX

In Canada: TELAK  
Scarborough, Ont.  
(416) 438-3804

Circle 39 on Reader Service Card

# Architectural Acoustics, part 1

*By following certain rules, you can design and build, or modify, studios to meet specific acoustic needs.*

Reprinted from db March 1968

**T**HE professional worker in audio is involved with acoustics, regardless of his specialty within his field. Indeed, the fields of audio and acoustics overlap more than they are separate and distinct. The acoustics of recording and broadcast studios, theaters, concert halls, and other performing spaces affect the work of the recording and broadcast engineer—while the acoustics of any space requiring an electronic sound amplification system will affect the performance of the system and the work of the system designer, installer, and operator.

A theater, concert hall, auditorium, or a radio or television studio should be designed acoustically: first to form a good *room-acoustic* link between the live sources of speech and/or music, and the live listeners and/or microphone(s); and second to exclude noise. Both the room-acoustics and noise-control aspects of architectural acoustics have been under continuous development for many years. The goals of the room-acoustics design may be stated as:

- Insuring an even distribution of sound energy throughout the space.
- Controlling discrete echoes, rapidly repeating echoes (flutter-echoes) and bunching of the normal modes of vibration of the rooms which might emphasize certain frequencies.
- Providing the proper reverberation time characteristics.
- Assuring the proper ratio of reverberant-to-early sound, related to the shape of the reverberation decay curve and particularly important in spaces where live music is heard by live listeners.
- Providing a short enough initial time-delay gap, for early reflections, again important in *live-music* spaces.

## Diffusivity and Echo Control

Even sound distribution and satisfactory control of echoes and normal modes is achieved where there are no extreme variations in sound pressure either as the frequency of the signal or the position in the room is varied. Diffusivity can be accomplished by avoidance of parallelism in the basic shape of the room, as in FIGURE 1, or large-scale modulations of basically rectangular shapes, as in FIGURE 2. The popular polycylindrical diffusers (FIGURE 3) are one form of “break-up” that can be added to basically rectangular-shaped rooms.

Where large, concave or flat surfaces are essential because of architectural or other planning considerations, echoes may be controlled by sound-absorbing treatment. Usually, however, diffusion by surface break-up and shaping should

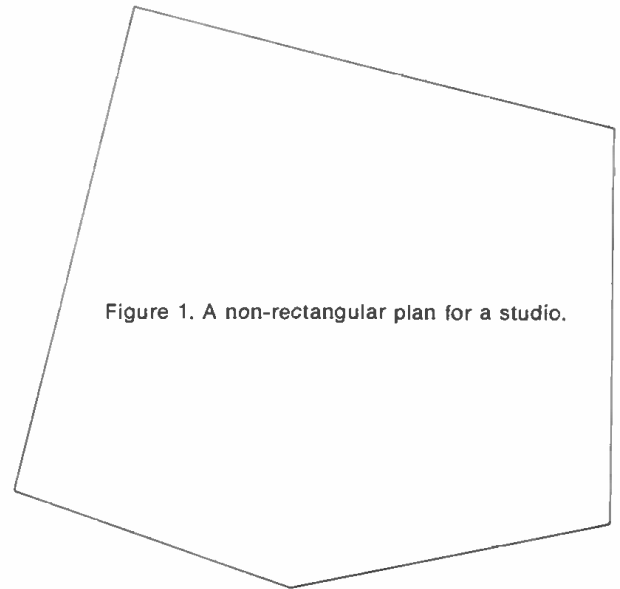

Figure 1. A non-rectangular plan for a studio.

be considered first and the sound-absorbing treatment limited to that required for reverberation control.

Elements added to basically rectangular rooms for sound diffusion must be approximately equal or larger in scale compared with the wavelengths of sound energy being controlled. (The wavelength of a 100 Hz signal is 11.3 feet.) For speech studios a designer might restrict diffusion to the range above 200 Hz (5.65 ft.), but for music studios the range down to 50 Hz (22.6 ft.) or even lower — to the 20 Hz lower limit of human hearing — may be important.

In many auditoriums and concert halls, balconies or applied decoration in the form of statues, etc. are “natural” sound-diffusing elements.

## Reverberation Time

We define reverberation time as the time required for sound to decay to one-millionth of its value (60 dB) after cessation of the sound source. In any real room it usually varies as a function of frequency and may be predicted accurately by the ratio of the volume of the room to the total sound-absorption present, according to the following formula<sup>1</sup>:

<sup>1</sup> This equation is called the Sabine equation after Wallace Clement Sabine, father of modern architectural acoustics. It appears generally applicable for most diffuse-large spaces, although the Norris Eyring equation or other modifications of Sabine's original equation are perhaps more appropriate for small or very dead rooms.



$$R_t \text{ (reverberation time)} = \frac{0.049 V}{S\alpha}$$

Where  $V$  = room volume  
 $S$  = room surface area  
 $\alpha$  = average absorption coefficient  
 $S\alpha$  = total sound absorption

Although early studios were uniformly dead, there has been a trend from the early days of broadcasting to the present for more reverberant studios, particularly for music performance.

Beranek's suggested criteria for speech, general, and music studios still appear to be generally applicable and are illustrated in FIGURE 4. Large music studios should have much the same reverberation time characteristic as a fine concert hall. Speech studios should have essentially no audible reverberation with less or equal reverberation time at frequency extremes (low-frequencies and high-frequencies) as compared with mid-frequencies.

General studios may be a compromise between speech studios and music studios. Regarding auditoriums for "live" listeners, experience suggests the following mid-frequency reverberation times for different uses:

	<i>Optimum</i>	<i>Possible<sup>2</sup></i>
Lectures	0.9 – 1.1	0.5 – 1.4
Drama (theaters)	0.9 – 1.4	0.5 – 1.6
Musical Comedy	1.2 – 1.5	1.0 – 1.7
Opera	1.5 – 1.8	1.4 – 2.0
Instrumental Recitals and Chamber Music	1.4 – 1.8	1.0 – 2.0
Orchestral Concerts	1.8 – 2.0	1.4 – 2.5
Vocal Recitals	1.5 – 1.8	1.4 – 2.0
Choral and Organ concerts (liturgical music – the upper limit depends on the type of music)	2.0 minimum	1.7 minimum

<sup>2</sup> Good results possible provided other parameters are optimized.

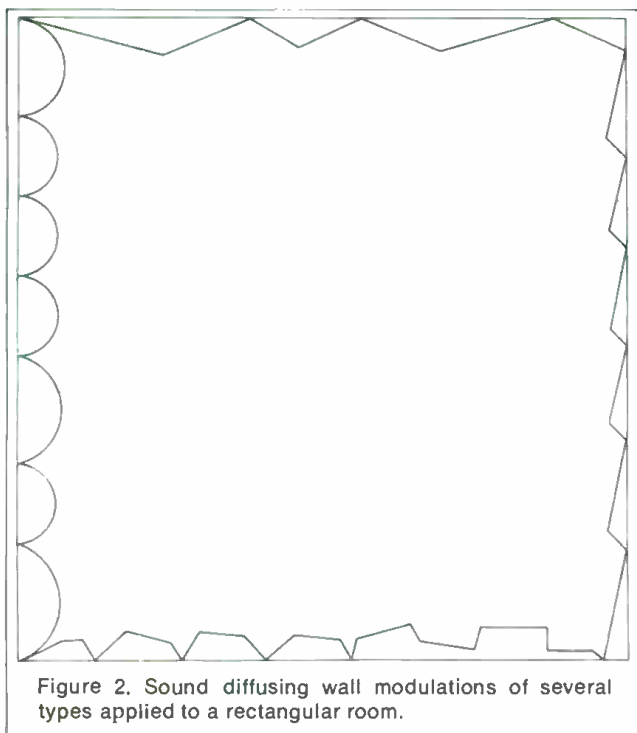

Figure 2. Sound diffusing wall modulations of several types applied to a rectangular room.

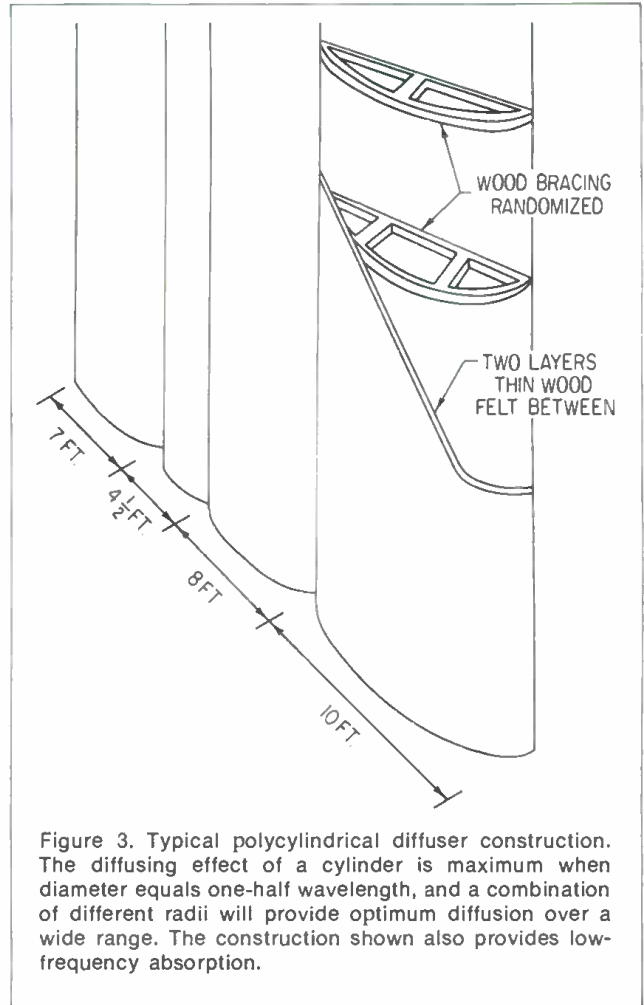

Figure 3. Typical polycylindrical diffuser construction. The diffusing effect of a cylinder is maximum when diameter equals one-half wavelength, and a combination of different radii will provide optimum diffusion over a wide range. The construction shown also provides low-frequency absorption.

Occasionally a reverberation time calculation will reveal a studio or auditorium on the "dead" side (too low a reverberation time), even without any applied sound-absorbing treatment. For example, the calculated reverberation time for a studio planned for music broadcasting may be under 1.5 seconds at mid-frequencies, even with all interior finish materials hard and sound-reflecting. The reason may be a relatively low cubic volume (interior volume less than say 40,000 cubic feet), with the predicted sound-absorption of the 100 members of a full symphony orchestra present.

Economics may dictate the design of studios or halls below optimum size. Under these conditions the wise designer or acoustical engineer will often refrain from attempting to make the hall or studio as live or reverberant as possible within the available volume, because under certain conditions in small halls or studios, he would be concerned that the space would simply be too loud for proper performance conditions. Instead, particularly in studio situations, he might choose to provide a relatively dry acoustical environment to be supplemented by electronic reverberation devices, either within the hall itself (for performers, listeners, and recordings) or for recordings alone.

We have been discussing mid-frequency reverberation time goals for various spaces. These are reverberation times measured in the 500–1000 Hz range. The variation in reverberation as a function of frequency is also very important; and it is a good measure of the "frequency response" of the room. For example, a concert hall with a reverberation time of 2.8 seconds at 125 Hz, 2.0 seconds at 500 and

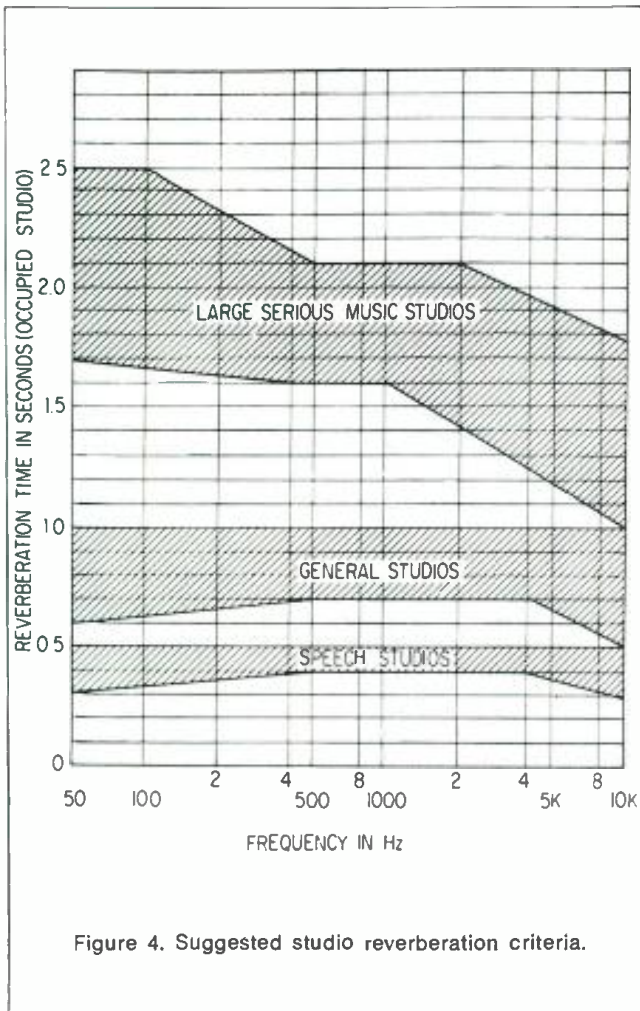

Figure 4. Suggested studio reverberation criteria.

1000 Hz and 1.6 seconds at 2000 Hz would be characterized as *warm*. On the other hand, a similar hall with reverberation times of 1.5 seconds, 2.0 seconds, and 2.0 seconds at 125, 500-1000, and 2000 Hz, respectively, would probably be characterized as *harsh*, or *bright*. Today, acoustical engineers plan large halls or studios for music performance to have rising low-frequency reverberation time characteristics: that is longer reverberation times at low frequencies than at middle or high frequencies.

In a speech studio, particularly a small one, a longer reverberation time characteristic at low frequencies would be characterized as a *boomy* acoustical environment. Speech-acoustics spaces should generally have flat reverberation time characteristics. Studios and auditoriums planned for both speech and music may be planned as a compromise, or — as discussed earlier — adjustable treatment or electronics may be employed to bridge the gap between optimum speech and optimum music conditions.

### Initial Time Delay Gap and Ratio of Early-to-Reverberant Sound

These quantities have been analyzed primarily with respect to concert hall acoustics — although there is every indication that we should consider them important in large speech halls also.

In a large concert hall having an “ideal” reverberation time characteristic (a long one, say 2.0 seconds) there can be a tendency for the sound heard by a live audience to be *muddy* or lack sufficient clarity, particularly for classic

(Mozart — Haydn) and contemporary (Stravinsky) music. Rather than shorten the reverberation time to obtain the added clarity, today’s acoustical engineer would rather supplement the direct sound with additional sound energy that arrives at the listeners’ ears soon enough to reinforce the direct sound, adding to clarity without destroying the richness of a long reverberation time. The goal is a “have your cake and eat it too” solution, which combines clarity and reverberation. Such a hall can have a large-hall liveness of sound with a small-hall intimacy. The time of arrival of these early reflections and their strength is important. If too late (after the initial sound) or too low in strength, they will be ineffective in aiding clarity: if they are too strong — and early enough — they will so dominate the sound heard by listeners that the liveness of the hall simply will not be heard, and the hall will have a reputation for *dryness* despite an adequately long reverberation time.

These early reflections may be compared to a pinch of pepper in a well-prepared soup. Just the right amount is needed. Too much and we’ll taste only the pepper (too *much* clarity); not enough and the pepper may as well be absent (too *little* clarity); and the pepper should be added at the right time for best effect (the proper initial time delay gap).

The amount of energy in the early reflections, together with the energy of the direct sound, determines the ratio of early-to-reverberant sound, while the timing determines the “initial time delay gap”. The ratio of early-to-reverberant sound is, for our purposes, defined as the ratio of sound energy received at a listener’s position for the first 50 milliseconds during and after the receipt of the initial pulse of sound to the total sound energy received after the first 50 milliseconds.<sup>3</sup> Often, the inverse ratio — the ratio of rever-

3 We assume use of a short-duration (5 milliseconds or less) pulse or impulsive sound source to obtain measurements of the quantities here discussed. Such sound sources would be analogous to transient sound in speech and music — the attack of a musical instrument or consonants in speech — rather than the steady-state or vowel sounds. Proper hearing of transients is necessary for adequate clarity.

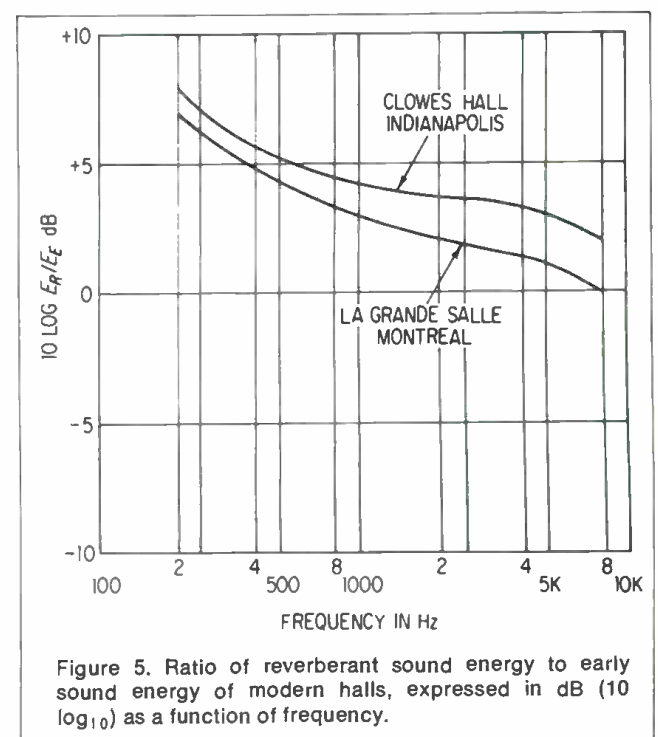

Figure 5. Ratio of reverberant sound energy to early sound energy of modern halls, expressed in dB (10 log<sub>10</sub>) as a function of frequency.



## The Beogram™ 4002. If you are serious about your audio system, there is no alternative.

The Beogram 4002 began when Bang & Olufsen engineers were told to set aside the traditional solutions to turntable design and begin anew. Their goal was simply stated: Develop an electronically controlled turntable with optimum specifications. The result of their work was the Beogram 4002, an audio component unequalled in both concept and performance.

**The cartridge.** The quality of any turntable is easily negated by using an inferior or mismatched cartridge. Bang & Olufsen engineers felt it was essential to develop a cartridge which was an integral part of the turntable and not simply an appendage added later by the user. Therefore, an entirely new cartridge was developed which could meet the specification levels set for the turntable. This cartridge was the MMC 6000; a brilliant piece of miniaturization capable of reproducing a frequency spectrum from 20 to 45,000Hz. The MMC 6000 features the new multi-radial Pramanik stylus for exceptional high frequency tracing and has effective tip mass of only 0.22mg. It has a tip resonance point of over 45,000Hz, a compliance higher than  $30 \times 10^{-7}$ , and a recommended vertical tracking force of 1 gram.

**The tone arm assembly.** The Beogram 4002 features one of the most sophisticated tone arm assemblies ever developed. Its tangen-

tial tracking effectively eliminates tracking error and skating force. When a record is being played, each revolution brings the stylus one groove's width closer to the center. This inward movement causes the tone arm to pivot the equivalent fraction of a degree and reduce the amount of light received by a photocell within the tone arm's housing. This causes a servo motor to very slowly move the entire assembly the exact distance required to compensate for the angular deviation. Precision, low-friction

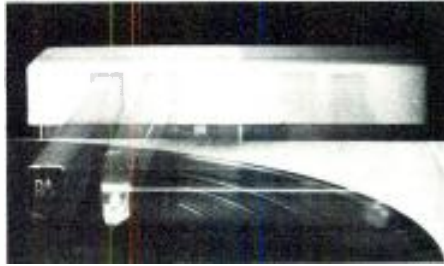

A color brochure presenting all Bang & Olufsen products in detail is available upon request.

## Bang & Olufsen

Fine instruments for the reproduction of music.

Bang & Olufsen of America, Inc.  
2271 Devon Avenue  
Elk Grove Village, Illinois 60007

ball bearings keep the vertical and horizontal friction of the tone arm to between 5 and 15mg. As the tone arm is always kept tangent with the record groove, skating force is eliminated.

**Operation.** The Beogram 4002 utilizes computer logic circuits for automatic control of the operation cycle. Once you have depressed the "on" switch further assistance is unnecessary. The detector arm preceding the tone arm senses the presence and size of the record and transmits the appropriate information to the control unit. If there is no record on the platter, the arm will be instructed to return to the rest position and shut off the unit. When a record is detected, the correct speed is automatically set and the stylus cued in the first groove. A patented electro-pneumatic damping system lowers the tone arm at a precise, controlled speed to prevent damage to the stylus. The entire cueing cycle takes only two seconds. The control panel of the Beogram 4002 also permits power assisted manual operation. You may move the tone arm in either direction and scan the entire record at slow or rapid speed. A slight touch on the control panel will lower the arm exactly in the groove you have chosen; another touch will immediately lift it for recuing elsewhere. During any operation, either manual or automatic, you need never touch the tone arm.

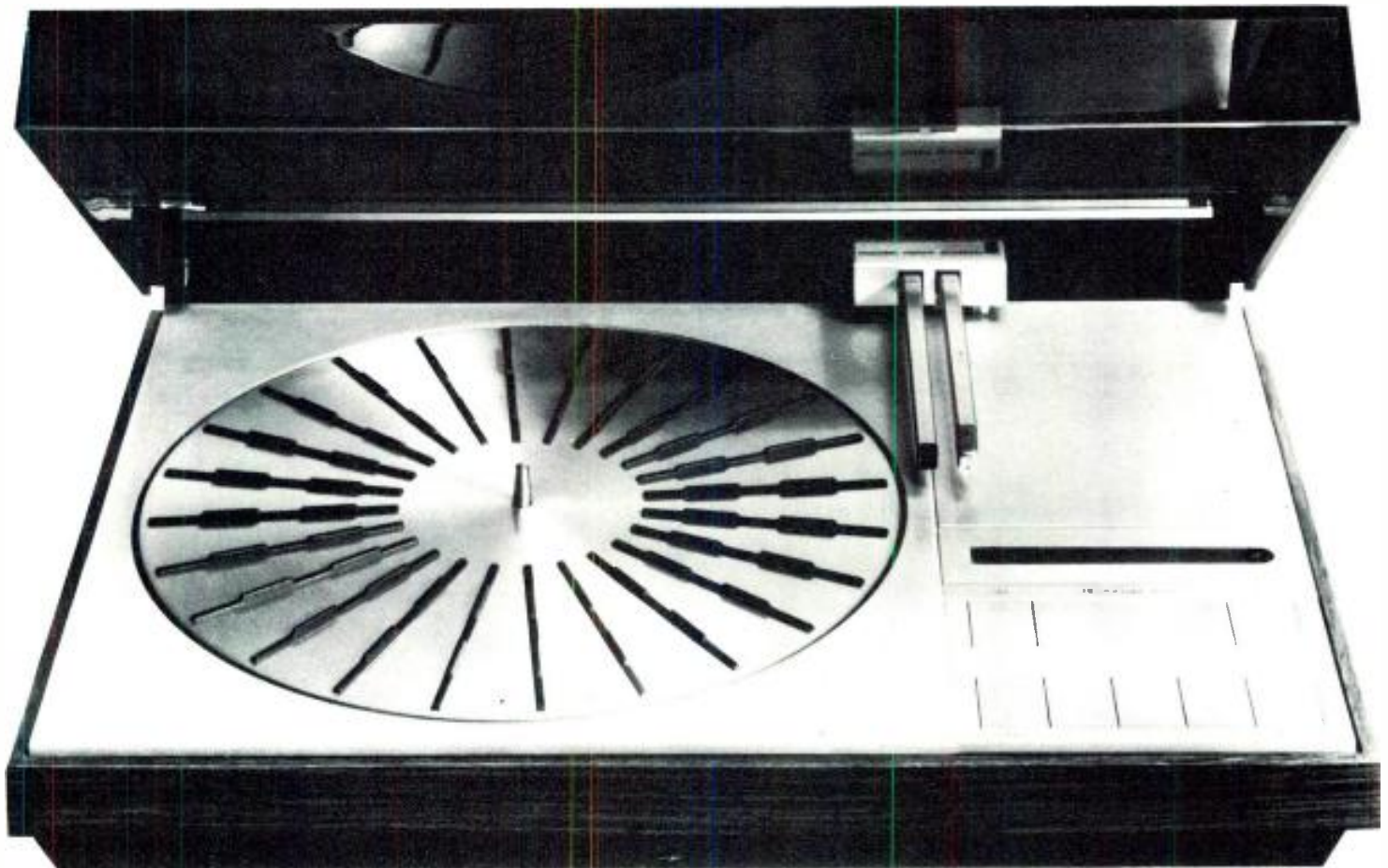

Bang & Olufsen components are in the permanent design collection of the Museum of Modern Art.

Circle 42 on Reader Service Card

[www.americanradiohistory.com](http://www.americanradiohistory.com)

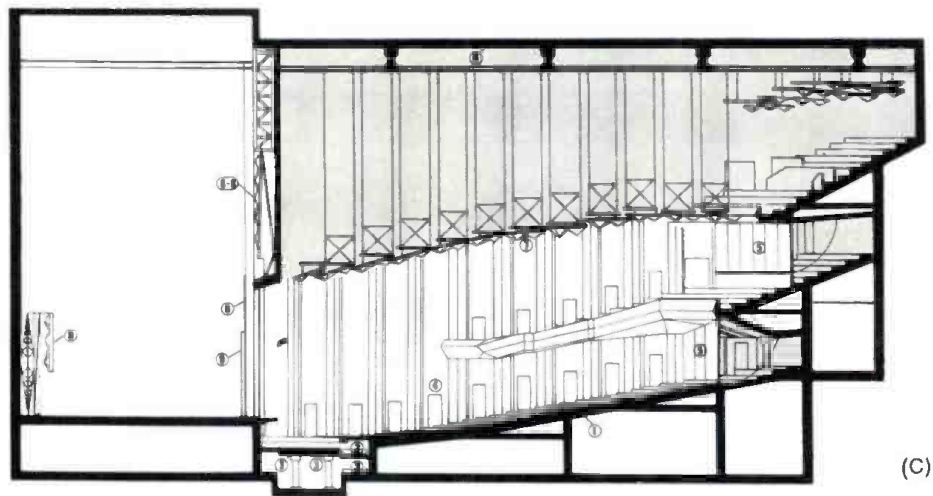
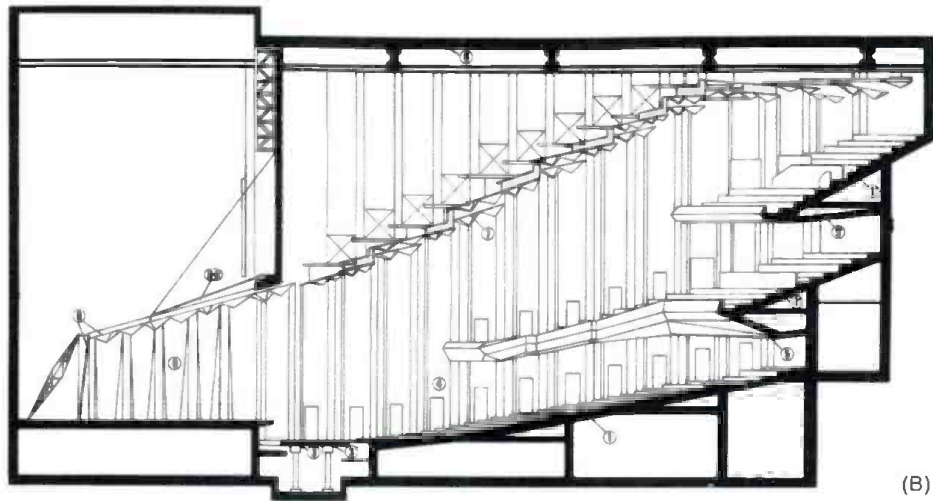
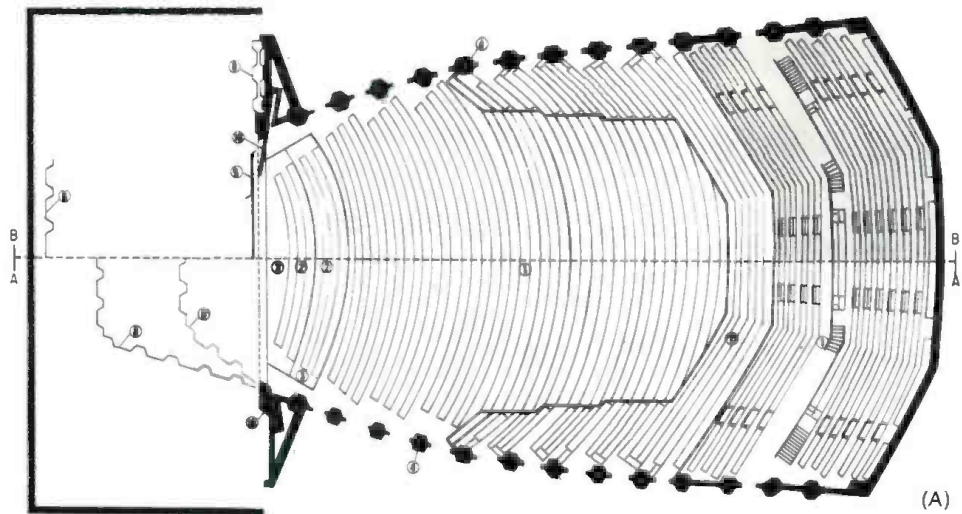

Figure 6. A 3000-seat Concert Hall-Opera House and 1700-seat Recital Hall-Theatre Combined in One Hall. (A)—Plan—left stage enclosure in position for 3000-seat concert hall, right, 1700-seat theatre, stage enclosure stored. (B)—Longitudinal section, stage enclosure in position for 3000-seat concert hall. (C)—Longitudinal section, stage enclosure stored for 1700-seat theatre.

1—Fixed Orchestra Seats 1'—Fixed Balcony Seats 2 and 2'—Movable Orchestra Seats 3 and 3'—Stage Apron Elevator 4—Fixed Auditorium Walls 5 and 5'—Sound-Transparent Movable Auditorium Walls 6—Fixed Audi-

torium Ceiling 7—Movable Auditorium Ceiling 8—Movable Stage Enclosure, Walls and Ceiling 8'—Movable Stage Enclosure Walls, Recital Position 9—Stage Teaser and Tormenter 10—Proscenium Pull-out Panels

Shaded areas are spaces closed off by movable ceiling and rear walls.



berant-to-early sound energy is used. The ratios are usually expressed in decibels rather than fractions. FIGURE 5 shows the ratios for two modern halls as a function of frequency.

The initial time delay gap is the delay between receipt of the initial sound and the receipt of the first reflection. Beranek's study (see Ref. 4) has indicated 0 to 20 milliseconds as ideal for the initial time delay gap, and up to 30 milliseconds as good.

The proper early-to-reverberant sound ratio and the initial time delay gap were inherent in the design of the older, narrow, rectangular "shoe box" concert halls. The designs included broken-up or diffuse side walls, spaced sufficiently close together (and to the halls' center-lines) to provide the required early reflections. However, the newer, larger and sometimes more radically shaped wide halls seem to require supplementary sound-reflecting *clouds* (Tanglewood; Clowes Hall in Indianapolis; Jones Hall in Houston; La Grand Salle, Place des Arts, Montreal; DeDolan Hall, Rotterdam; for example) or one large sound reflector per hall in the form of a "lip" (Saratoga Springs; Chandler Pavillion, Los Angeles; Opera House, Seattle) to assure the right balance between clarity and liveness.

The recording engineer may not be overly concerned with these balances. Given a sufficiently live hall, he can increase clarity by closer microphoning or use of more directional microphones; or increase liveness by use of more omnidirectional microphones or greater distance from source to microphones.

The sound-system designer may broaden his understanding of room acoustics problems to have a better grasp of the combined room-sound system results. In special cases, where architectural means are impractical, an electronic sound reinforcement system may be called upon to simulate early reflections by amplified sound.

### Stage Enclosures

Auditoriums used for opera and plays usually have generous fly-space over the stage and side-stage areas to permit movement of scenery and curtains. These voids can act as traps for sound energy during live music performances; the proscenium (stage opening) acts as a barrier between the musicians on the stage and the audience. A music studio or concert hall surrounds an orchestra with many hard, sound-reflecting surfaces. Movable stage enclosures accomplish the same results in multi-purpose auditoriums, they help in the "quick-change act" between theater and concert hall. When in place, the enclosure assures that the audience and performers are in the "same room".

To be fully efficient, such enclosures should usually be constructed of fairly heavy material, usually weighing 2 lbs./sq. ft. or more, to reflect low-frequency sound energy which can pass through thin, lightweight material. Half-inch or three-quarter-inch plywood is a popular material for stage enclosures, both custom-built for particular halls and available from stock from several manufacturers.

Good critical reviews have greeted concerts performed within relatively lightweight enclosures. These enclosures employ a process which has been described as *selective absorption* to achieve optimum frequency response and instrumental balance. Gaps are left in certain areas of the enclosure to absorb middle and high-frequency energy, balancing the absorption of bass energy by thinner than usual material.

The usual system for the erection of a movable stage enclosure is for the ceiling pieces to be suspended on the

theatrical rigging system, with the walls in the form of interlocking self-supporting pieces or rolling towers. There is a trend, however, to mechanized stage enclosures that reduce dependence upon normal stage-hand labor for erection and striking while freeing the rigging system completely for its prime purpose of storing scenery. In the Jesse H. Jones Hall for the Performing Arts, Houston, Texas, the forward ceiling panels of the stage enclosure fold down as one unit from the stage house wall above the proscenium, the side-walls fold out from the stagehouse walls on each side of the stagehouse, and the rear wall and rear ceiling fold out from the lower up-stage (rear stagehouse) walls. All this is accomplished with the help of push-buttons and electric motors. Such a theater design can free the acoustical designer toward the use of adequately heavy materials, regardless of their weight. In this case, 12 gauge steel, backed with damping material and faced with thin wood veneer was employed. The surface weight of the combined structure is close to 7 lb./sq. ft., assuring good sound reflection down to 25 Hz.

The improvement of an existing multipurpose theater-concert hall by provision of a properly designed stage enclosure, whether wood, plastic, or damped metal, is a familiar event today. Often the improvement in hearing conditions for the live audience is matched by improvements in liveness and balance in the sound as picked up by microphones; however, more often than not complete re-engineering of the microphone pickup arrangements are required if best results are to be obtained. ■

**listen**

If your business is providing or operating quality sound systems for musical performances...

Listen to the sound of live music with a conventional reinforcement system and then with the unconventional BOSE 800 system.

Only BOSE lets through the clear, natural sound of the live musical performance... without traditional sound system coloration. Prove it to yourself. Just listen.

**BOSE**®

Please send information on the BOSE 800 to:

Name \_\_\_\_\_

Address \_\_\_\_\_

City/State/Zip \_\_\_\_\_

BOSE The Mountain, Framingham, MA 01701 Dept. DP

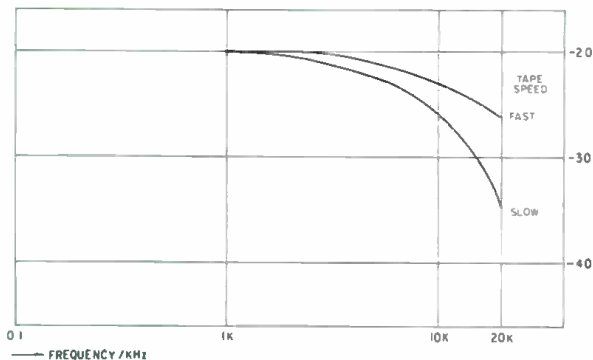

Figure 1. Typical high frequency losses of a constant current recording (no record pre-emphasis) well below tape saturation.

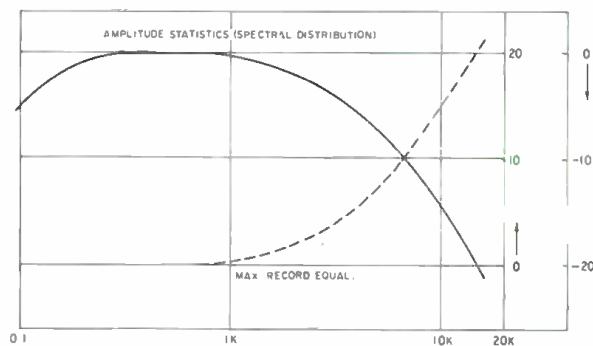

Figure 2. Amplitude statistics (spectral distribution).

JOSEF W. DORNER

# Why Use 15-ips Tape Speed?

*Is 15 in./sec. tape sometimes an extravagance when measuring frequency response? Points in favor may help you make a logical, and most economical, decision.*

**A**S IN TEVYE the dairyman's world, audio procedures, young as they are, have already established their traditions. One of these is the practice of measuring a tape record's frequency response some 20 dB below full modulation, in order to avoid the possibility of tape saturation at high frequencies as the result of the high-frequency boost required in the recording process. Iconoclastic audio engineers might ask, if the specification sheets for recorders running at 7½ and 15 in./sec. show almost identical performance data, why use twice as much tape at 15 in./sec. if the same results can be obtained at 7½ in./sec. anyway?

The answer is not, as Tevye melodiously put it, "Tradition." It's not even as your mother might have said, "Because." This particular practice is based on sound reasons (pun unintentional).

First, we may ask, "Is there really a difference in quality between a 7½ and a 15 in./sec. recording, and if so, why?"

Let's consider record and playback equalization, the electrical transfer characteristics of the amplifier, which, if properly adjusted, will produce a linear over-all frequency response with a given recording tape. If such equalization were not used and a recording made with constant audio current passing through the recording head over the whole audible frequency range, the output would remain constant at first. But as higher frequencies were approached, a drooping response would become evident. This fall-off of high frequencies would be more severe at a slow tape speed than at higher ones. This effect is shown in FIGURE 1. The amount of high-frequency loss depends on a number of variables, including the tape; therefore, the curves represent only the general trend and are not to be taken as absolute figures.

## COMPENSATING FOR LOSS

This loss at high frequencies is a wavelength-dependent effect. The wave length of a given frequency becomes shorter on tape as tape speed is reduced. Record equalization is used to compensate for this loss of highs. An increasing amount of current is pushed through the head with rising frequency and decreasing tape speed. That is possible, to a certain degree, because high-frequency

Josef Dorner is an audio engineer in Zurich, Switzerland



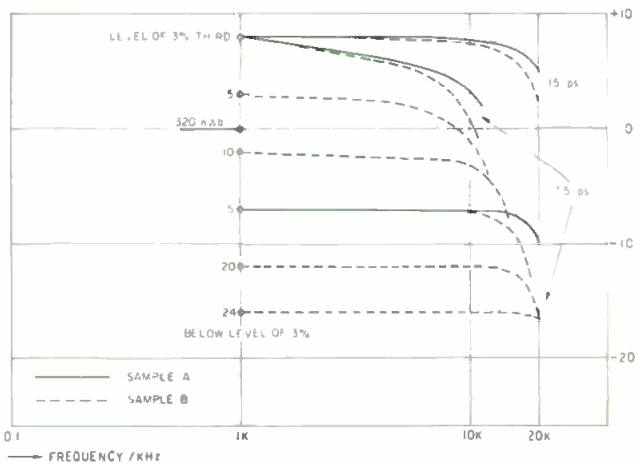

Figure 3. Frequency response at different speeds and different levels.

sounds in voice and music have rather low energy levels. They may be lifted up to produce on tape a level of magnetization which is stronger than their presence in a live performance. Compensation becomes effective for the losses which occur in the magnetic recording and playback process, maintaining the same spectral energy distribution as an over-all effect. To avoid tape saturation, the emphasis must not exceed the amount by which the high frequencies are present at a lower level in the original sound.

Based on various measurements, a curve (FIGURE 2) has become widely accepted and is considered representative of the average intensity levels in a wide variety of live sounds (spectral distribution.) The inverse of that curve is taken to be the maximum permissible record equalization for any recording process.

However, various researchers<sup>1,2</sup> have shown that spectral energy distribution may vary widely, in some cases being flat up to 16 kHz, within 3 to 5 dB. Obviously, the record equalization that must be used for music with such a high energy content at the treble frequencies will drive the magnetic oxide into saturation.

We can simulate this by trying to run a frequency response on a recorder, not at the conventional level of -20 dB but at a peak recording level instead. The results will reveal an interesting insight into what actually happens to the frequency response of a recording at different speeds and at different levels of magnetization.

### STUDYING OUTPUTS

In FIGURE 3, we see the graphic presentation of a typical performance obtained with modern high-output tapes on a high-quality tape recorder. From these graphs, one can conclude the following: A slow speed recorder will drive the tape into saturation at comparatively low levels; musical selections with high intensity of high-frequency sounds cannot be recorded without severe losses at the upper spectrum. A recording tape may have reduced saturation characteristics at short wavelengths, causing high-frequency saturation to occur much sooner than on other magnetic oxides. (See FIGURE 3, samples (A) and (B) at -15dB.)

Not only the frequency response has to be considered in such an evaluation, but some difficult-to-measure distortion products are generated when saturation is reached at high frequencies, causing the recorded sound to take on a fuzzy quality as a result of the different intermodulation products which are generated.

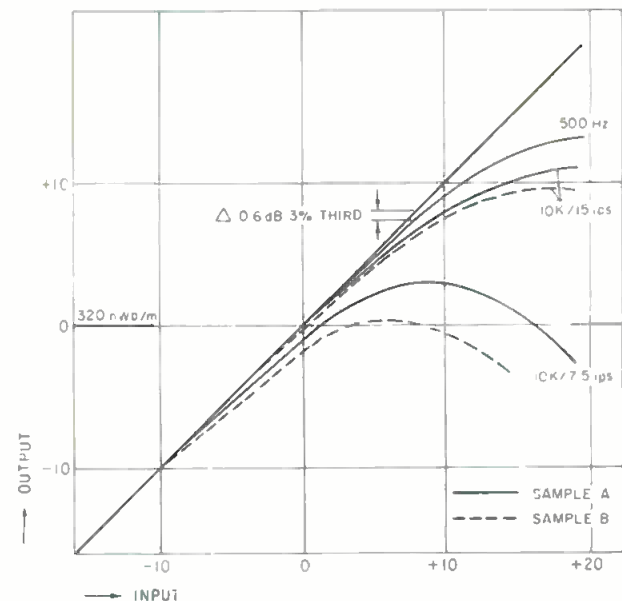

Figure 4. Saturation characteristics at high and low frequencies for different speeds and different modern high-output low noise oxides.

### COMPRESSION EFFECT

By investigating a tape's transfer characteristic at long wavelengths, we see that a compression effect (about 0.6 dB) becomes evident at a level which corresponds to the universally tolerated maximum of 3 percent of third harmonic. At the point where 1 dB of compression is reached, distortion already measures 12 percent. At the high frequencies (e.g. 10 kHz) distortion products are difficult or impossible to measure because the limited frequency response of the replay electronics does not normally allow the determination of their third harmonic content. That leaves only one alternative, to consider the point of 0.6 dB compression at 10 kHz as the highest tolerable modulation level. On the two tapes under investigation, that point was only a few dB below the 3 percent distortion mark for 500 Hz when using the speed of 15 ips. At 7½ ips, however, the tapes began to show compression (distortion) at 10 kHz at a much lower level, as can be seen in FIGURE 4.

Attempts are being made by at least one national standards organization to express a recording system's high-frequency saturation performance in terms of a decibel value for its signal-to-noise performance at a specified frequency. More accurate tests, such as the recording of two closely spaced high frequencies at different levels of magnetization while measuring their third-order product, will also yield very useful information.

In any event, it is apparent that the special characteristics offered by modern magnetic oxides should be carefully weighed against such desirable features as improved signal-to-noise ratio and extended frequency response, if the risk of high-frequency overmodulation is to be kept as low as possible. The purpose of using 15-ips tape is not just a caprice, or because someone else does it. It is necessary for that margin of excellence necessary to preserve on tape all the sparkle of a live performance. ■

### REFERENCES

1. McKnight, John G., "The Distribution of Peak Energy," *Journal of the Audio Engineering Society*, April 1969, p. 65.
2. Bauer, Benjamin, "Octave Band Spectral Distribution," *AES Journal*, April 1970, p. 165.

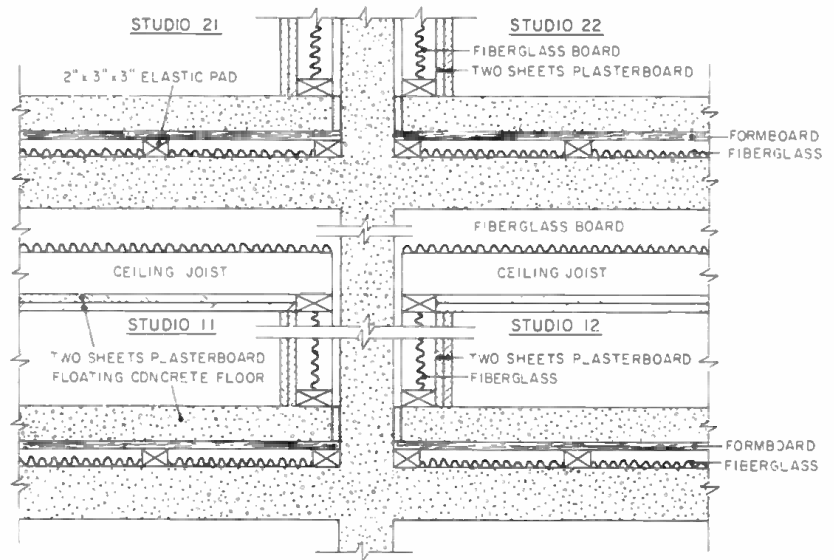

Figure 1. Cross-section of a studio complex, showing a floating concrete floor.

# Recording Studio Acoustics, Part 6

*Attenuation of noise from exterior sources, such as air-conditioning equipment, overhead noise, and traffic requires careful structural modifications.*

**MICHAEL RETTINGER**

**E**XCEPT WHERE SPACE is severely limited, two or three recording studios of different volumes are preferable to one large studio with variable volume. Reasonably acceptable proportions for height, width, and length cannot be maintained for all possible studio volumes by moving one wall or by lowering the ceiling of the room. When massive movable walls or a massive ceiling are employed to achieve a low noise level in the enclosure, the cost of the moving mechanism becomes very high. The acoustic treatment cannot be optimally distributed for all possible volumes unless a second mechanism is employed to change the acoustic treatment along with the volume.

Multiple studios may be horizontally or vertically disposed. In either case, each studio should have a floating floor, that is, a resiliently supported concrete slab, for efficient sound and vibration control.

## FLOATING FLOORS

FIGURE 1 shows a cross-section of an elaborate studio complex for a government project in Ryadh, Saudi Arabia.

A floating concrete floor, besides acting as a second bar-

Part 6 concludes *db's* series, Michael Rettinger's "Recording Studio Acoustics." Mr. Rettinger is an acoustical consultant in Encino, California.



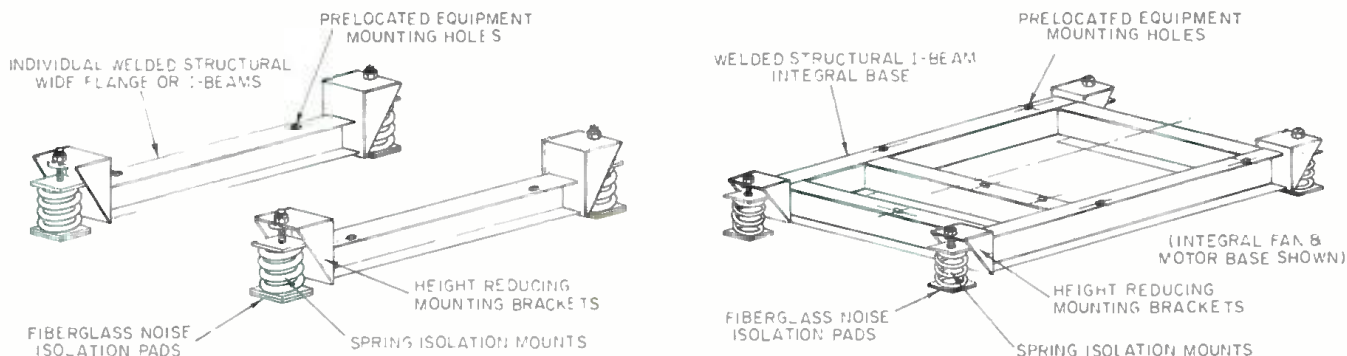

Figure 2. Structural rail equipment bases.

rier for airborne sound, also represents a type of inertia block which absorbs the mechanical vibrations of impulsive disturbances like footfalls, the moving of furniture or instruments, etc. Because of the elastic support below the floor, such a floating slab behaves as a low-pass mechanical filter whose cut-off frequency is given by  $f_n = 3.13/(d)^{1/2}$ , where  $d$  is the static deflection, in inches, of the compliant mount below the floating floor upon application of the concrete slab load.

In the case of a studio 30 ft. wide and 50 ft. long, 1,500 sq.ft., a 4-in. thick concrete floor will weigh 75,000 lb., or 50 lb./sq.ft. A 2-in. thick, 3 x 3-in. Neoprene, cork, or precompressed plastic-jacketed fiberglass pad may be loaded to 20 lb./sq.in., or 180 lb./pad. Hence  $75,000/180 = 416$  pads will be required. They may be spaced 2 ft. on center, with 16 pads along the width and 26 pads along the length of the floor. Considerable steel reinforcing rods will be necessary to prevent cracking of the concrete floor, which may also necessitate several expansion joints. The concrete should be poured on a sturdy formboard, such as a 3/4-in. thick exterior plywood on which a waterproof plastic sheet has been placed to prevent water-infiltration into the wood.

### RESILIENTLY HUNG CEILING

Another structurally isolated sound barrier is represented by a resiliently hung ceiling. Much in the manner of elastic pads spaced at 2-ft. centers under a floating concrete floor, a gridwork of channel iron and metal lath is hung by means of spring or Neoprene hangers from the overhead structural building slab. The lath is then plastered, generally after some fiberglass material has been placed above the lath for sound absorption in the space between slab and ceiling.

The cheapest footfall attenuator from an upper to a lower studio is undoubtedly a thick carpet with an equally thick underlay. The disadvantage of such a floor treatment lies in the fact that no strong first reflections from musical instruments can be had from such a covering. To lay plywood panels on the carpet near an orchestra shell is merely a makeshift procedure. Such a device is simply an improvised floating floor, without aesthetic appeal and of dubious quality acoustically because of the high damping.

### MULTI-STUDIO CONSTRUCTION

In multi-studio construction, corridors often can be placed advantageously to act as highly effective sound attenuators. In one instance, a corridor between a 12-in.

thick concrete block outside boundary and a studio with double-stud walls reduced the noise from a near jet-aircraft run-up operation to complete inaudibility in the studio.

The construction must be carried out properly. Not to plaster a concrete-block wall is to invite unexpected high sound transmission through it. Even painting such a wall has increased its sound insulation by as much as 6 dB over the entire audio frequency range, and plastering it on both sides has increased it by 12 dB over the same range. Concrete blocks are rarely sufficiently dry when they are delivered to the job. Shrinkage is bound to occur with consequent openings in the wall, particularly at the joints, which by themselves are often so porous it is possible to blow cigaret smoke through them. Every core in every block, not only every second or third core, must be filled with concrete to obtain the necessary surface density for the wall, together with the required seals.

Corridors should be constructed in the same way as studios if they are to act as effective sound attenuators. Thus, their floors should be floated on elastic pads, their ceilings should be resiliently hung from overhead structural slabs, and a generous amount of sound-absorbent material applied to both the ceiling and the walls. Rubber pads should be placed on the floor to attenuate the sound of footfalls and the trundling of carts. *(continued)*

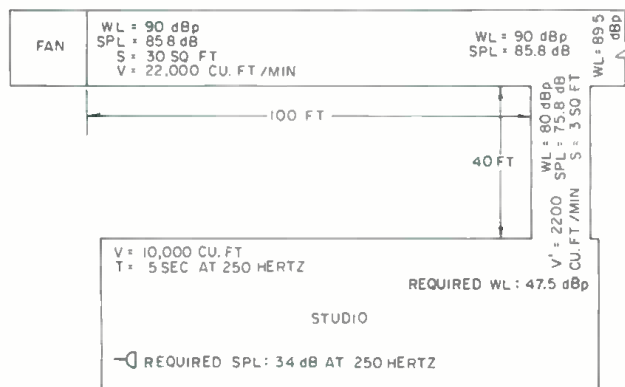

Figure 3. Duct-silencer.

Solve all studio timing problems with ingeniously simple, low-priced digital timers from...



ES-300



ES-302



ES-500



ES-134



ES-400



ES-510

- ES-300:** A 100 minute up/down timer with incandescent digital display & momentary pushbutton controls on top of an etched aluminum case.  
 DIMENSIONS: 2 3/4" high x 8" wide x 5 3/4" deep  
 ELECTRICAL: 117 VAC 60 Hz 10W max.  
 OPTIONS: B,D,G,H,J,K,P,Q,R,S,T,WY Price: \$168.00
- ES-301:** Same as the ES-300 except with Planar gas discharge display.  
 DIMENSIONS: 2 1/2" high x 8" wide x 6" deep  
 ELECTRICAL: 117 VAC 60 Hz 7W max.  
 OPTIONS: B,D,G,H,J,K,P,Q,R,S,T,WY Price: \$185.00
- ES-302:** Same features as the ES-301 PLUS lever-wheel, fast-set programming  
 DIMENSIONS: 2 1/2" high x 10" wide x 6" deep Price: \$238.00
- ES-400:** Three-digit, ten minute timer in etched aluminum case.  
 DIMENSIONS: 2 3/4" high x 6" wide x 5 3/4" deep  
 ELECTRICAL: 117 VAC 60 Hz 8W max.  
 OPTIONS: B,D,J,K,K,P,Q,R,S,T,W Price: \$98.00
- ES-510:** Four-digit, sixty minute timer with momentary pushbutton controls and etched aluminum case.  
 DIMENSIONS: 2 3/4" high x 6" wide x 5 3/4" deep  
 ELECTRICAL: 117 VAC 60 Hz 8W max.  
 OPTIONS: B,D,J,K,K,P,Q,R,S,T,W Price: \$125.00
- ES-132:** Twelve volt, 12 hour D.C. digital clock in black anodized aluminum case: no 60 Hz Hum-m-m-m.  
 DIMENSIONS: 4 3/4" high x 3 3/4" wide x 1" deep  
 ELECTRICAL: 12 VDC  
 OPTIONS: B,D,E,F,J,K,P,Q,R,S,W Price: \$200.00
- ES-134:** Same as the ES-132 except 24-hour, military time. Price: \$200.00
- ES-500:** A twelve-hour, six digit, combination clock/timer with five action momentary pushbutton controls: etched aluminum case.  
 DIMENSIONS: 2 3/4" high x 8" wide x 5 3/4" deep  
 ELECTRICAL: 117 VAC 60 Hz 12W max.  
 OPTIONS: B,C,D,J,K,P,Q,R,S,W Price: \$150.00

OPTIONS			
B	BCD Output	J	220 VAC, 50 Hz
C	Crystal Timebase	K	Kit
D	Remote Connector, 6' Cable and Pushbutton Set	P	1 9/16" Front Panel, 3 1/2" high
E	AC Operation with Crystal Timebase	Q	9" Front Panel, 3 1/2" high
F	AC Operation with Line Frequency Timebase	R	Remote Connector
G	Stop at Zero	S	Slave
H	Relay Contact Closure and Stop at Zero	T	Tenths of Seconds
		W	Three Wire Cord and Molded Plug
		Y	Relay Contact Closure at Zero

Call or Write for our catalog of Timers, Counters, Measurers, Programmers, Clocks and Simple Solutions To Custom Problems.



505 1/2 CENTINELA • INGLEWOOD, CA 90302  
 (213) 674-3021

Reliable, Simple Products Designed To Serve You, Not "Break You."

## AIR-CONDITIONER VIBRATIONS

In large studio installations, the location of the air-conditioning system equipment often becomes a critical problem. This situation is made more difficult because of the almost conspiratorial silence regarding machinery vibration levels on the part of equipment manufacturers. On more than one occasion, I have had to check the disturbances of an existing installation employing the compressors or chillers for the planned studio to be able to arrive at the necessary vibration isolation measures. When no such investigation is possible, it is advisable to over-engineer the attenuation. That may save extraordinary expense at a later date, if it is found that the equipment is audible in the studio.

My experience is that for most installations, the air-conditioning system machinery near the studio must be placed on inertia blocks. These should be mounted either on very tall springs (to achieve, sometimes a required 3-in. static deflection) or else on pneumatic mounts with an automatic feedback of air into the bags in case "bleeding" should occur over a prolonged period. Never place tall springs directly under equipment; that causes a wobbly motion on part of the machinery. They should be placed under a cradle, a heavy metal bar with upturned ends under which the springs can be located to produce a low center of gravity (FIGURE 2).

Needless to say, the use of an inertia block which may weigh several times as much as the machinery on which it is to be mounted requires consultation with the structural engineer of the studio project so that he may specify sufficient steel in the floor support.

## SOUND POWER LEVELS

As good practice, one describes the noise of air-conditioning equipment in terms of octave-band sound power levels to make the rating independent of distance and thereby to facilitate the acoustic design of the installation. Because both the sound-pressure level *SPL* and the power level *WL* are expressed in decibels, the latter are noted as *dBp's*, the *p* standing for *picowatts* ( $10^{-2}$  watts) as the reference level. A numerical example will illustrate the use of this system.

Assume a fan with a *WL* of 90 *dBp* in the octave whose mid-frequency is 250 hertz. This fan has a 30-sq.ft. S-port, *S*, capable of delivering 22,000 cu.ft. of air per minute. A 100-ft.-long unlined duct of the same cross-sectional area is to be connected to the fan. At the other end of this main feeder, the duct branches off into a 40-ft.-long, 3-sq.ft. duct to deliver 2,200 cu.ft. of air/min. at a *WL* of 47.5 *dBp* into a studio with a volume *V*, of 10,000 cu.ft. and a reverberation time, *T*, of 0.5 sec. at 250 hertz. What are the *SPLs* and *WLs* at the various points, why the 47.5 *dBp*, and how can this specification be achieved?

At the port, where *WL* is 90 *dBp*, the *SPL* is:

$$SPL = WL - 10 \log S + 10.6$$

$$= 90 - 10 \log 30 + 10.6 = 85.8 \text{ dB}$$

At 100 ft. from the port, the *WL* and *SPL* are still 90 *dBp* and 85.8 *dB*, respectively, because there is no spreading of the sound in the duct. At the branch, the *WL* in the 3-sq.ft. section will be  $10 \log(3/10) = -10 \text{ dB}$  less, or 80 *dBp*. The *SPL* will also be 10 *dB* less, or 75.8 *dB*. At the end of the 40-ft. long line, the *WL* and *SPL* are the same as at the branch end, since the studio is to have a noise level spectrum of NC-20, with an *SPL* of 34 *dB* at 250 hertz, the *WL* at the ceiling has to be:

$$WL = SPL + 10 \log V - 10 \log T - 29.5$$

$$= 34 + 10 \log 10^4 - 10 \log .5 - 29.5$$

$$= 47.5 \text{ dBp.}$$

Hence, in the 40-ft.-long line a duct-silencer with a dynamic insertion loss of  $80 - 47.5 = 32.5 \text{ dBp}$  at 250 hertz is required to achieve NC-20 in the studio (see FIGURE 3).



Closing date is the fifteenth of the second month preceding the date of issue.

Send copy to: Classified Ad Dept.

db THE SOUND ENGINEERING MAGAZINE  
1120 Old Country Road, Plainview, New York 11803

Rates are 50¢ a word for commercial advertisements.

Employment offered or wanted ads are accepted at 25¢ per word.

Frequency discounts: 3 times, 10%; 6 times, 20%; 12 times, 33%.

## FOR SALE

**MONITOR EQUALIZERS** for your Altec & J.B.L.s are a steal at \$75/channel

+

**FREE ROOM EQUALIZATION** with purchase of 1/3 octave filters. This is not a misprint. **Music & Sound, Ltd.**, 11 1/2 Old York Rd., Willow Grove, Pa. 19090. (215) 659-9251.

→ **S.M.E. Damping Mods—\$30.00** ←

**CASSETTE LABELS**, blank and custom printed. Free samples. **Tarzac**, 638 Muskogee Ave., Norfolk, Va. 23509.

**EMS SYNTHESIZERS**. Find out how you can save money on EMS systems. We promise it's worth your while. Write **EMSA**, 460 West St. (S), Amherst, Mass. 01002.

## ORTOFON

**DYNAMIC MOTIONAL FEEDBACK** mono disc cutting system. Complete amplifier system: drive, feedback, and feedback-playback monitor preamp; rebuilt, original factory parts. Guaranteed. **Albert B. Grundy**, 64 University Place, New York, N.Y. 10003. (212) 929-8364.

**RENT AN 8-TRACK SCULLY** by the day/week. Contact **F. Rubin**, (212) 631-5919.

**LEBOW LABS, INC.**, 56 Chestnut Hill Ave., Boston Mass. 02135. New England's foremost pro audio/video distributor, representing over 100 major manufacturers. Sales, consulting, design, and service by expert staff. Broadcasting, industrial, educational, and recording installations. **Frank Petrella**, (617) 337-6303, (617) 782-0600.

**ONE STOP  
FOR ALL YOUR PROFESSIONAL  
AUDIO REQUIREMENTS  
BOTTOM LINE ORIENTED  
F. T. C. BREWER CO.  
P.O. Box 8057, Pensacola, Fla. 32505**

**BROADCAST AND RECORDING EQUIPMENT:** Scully; Metrotech; Langevine; Electrodyne; Q.R.K.; Micro-Trak; M.R.L.; Nortronics; McMartin; U.R.E.I.; Revox; Crown; Byer; Lamb; Master Room; Stellavox; E.V.; A.K.G.; Sennheiser; Atlas; Ferrograph; HAECO; Stevenson; Gately; dbx; Advent; Altec; Fairchild; Audio Designs; 3M; Magnacord; Telex; Inovonics. Disc recording systems; package deals; installations; service. **Wiegand Audio**, Middleburg, Pennsylvania 17842. (717) 837-1444.

**AMPEX SPARE PARTS; technical support; updating kits, for discontinued professional audio models; available from VIF International**, Box 1555, Mountain View, Ca. 94042. (408) 739-9740.

**LOWEST PRICES IN THE COUNTRY** on microphones, power amps, speakers, musical instruments, P.A. equipment, including Peavey, Heil, J.B.L.; huge stock, top brands only. **Gracin's 110**, 606 Rte. 110, Huntington, N.Y. 11746. (516) 549-5155.

**NEW MODELS:** Ampex AG440C 2-track, servo capstan motor; Scully 280B; used AG440Bs; used Scully 280, 8-track, new heads, in console, excellent condition; Sennheiser mics. Immediate delivery from stock. **Malaco Recording**, Jackson, Miss. (601) 982-4522.

## MCI . . . Now the BEST SELLING multi-track recorder!

MCI . . . only from Audiotechniques, Inc. in the great northeast! Tape recorders from one track to 24 track. Recording consoles up to 40 input. MCI sales-service, Factory trained technicians. Studio design and construction service.

**Audiotechniques, Inc.**  
142 Hamilton Ave.  
Stamford, Conn. 06902  
(203) 359-2312.

**SPLICE FASTER, BETTER, BY SHEARING;** replaces razor; attached splicing tape dispenser; quality workmanship; reasonably priced; endorsed by professionals. \$24.95 prepaid. Guaranteed. Distributors wanted. **NRP**, Box 289, McLean, Virginia 22101.

**REELS AND BOXES**, 7" and 5" large and small hubs; heavy duty white boxes. **W-M Sales**, 2010 Balboa, Dallas, Texas 75224.

**ONE WAY NOISE REDUCTION** for cutting rooms/tape copies; retains highs, rids hiss/surface noise & clicks/pops by a full 10-14 dB and costs \$150 up per channel! **Music & Sound, Ltd.**, 11 1/2 Old York Rd., Willow Grove, Pa. 19090. (215) 659-9251.

**FOR SALE: TWO (NEW) ELECTRO-SOUND ES-505C** two-track, \$2,650.00 each; one Spectra Sonics 502 w/amp, \$180.00; one SS model 403RS power supply ±24V, \$130.00; one SS model 400RS 24V, \$125.00. **RM Sound & Co. Inc.**, P.O. Box 72, New Berlin, Wisconsin 53151.

**FOR SALE: DOLBY M-16**, \$7,800.00; 3M 206 2500' 2" w/reel & box, \$20.00; 1", \$10.00 (min. order, 10 reels). **Sound 80, Inc.**, 2709 E. 25th St., Minneapolis, Minn. 55406. (612) 721-6341.

**I'M BLOWING A DIFFERENT TUNE!**  
**FOR SALE:** Bassoon, Polisi standard; perfect condition, only two years old. \$800.00. **Box 61**, db Magazine, 1120 Old Country Rd., Plainview, N.Y. 11803.

**FOR SALE: TASCAM 4-track 701**, \$1,900; Tascam 2-track 701, \$1,500; dbx RM157, \$950; Advent Dolby B, \$175; custom consoles, \$100 each; dbx 161 compressor, \$215; other equipment available. Call: 301-933-9221 or write: **Willow Mill Recorders**, 2807 University Blvd. W., Kensington, Md. 20795.

## MULTI-TRACK

- ★ SERIES "B" MIXING CONSOLE
- ★ VARI-BAND 5 SECTION PARAMETERIC EQUALIZER
- ★ DUAL EQUALIZED REVERB
- ★ LONG & SHORT THROW SLIDE FADERS
- ★ HIGH BALLISTIC VU METER

P.O. BOX 3187  
HOLLYWOOD, CA 90028  
(213) 467-7890

**NEW YORK'S LEADING PRO AUDIO/VIDEO DISTRIBUTOR** for audio, video, broadcast, public address, and hi-fi systems; representing over 130 audio/video manufacturers, featuring such names as Ampex, Scully, Tascam, Sony, J. B. Lansing, Neumann, Altec, McIntosh, AKG, Dynair, T.V. Microtime, UREI, 3M, and other major brands; the largest "in stock" inventory of equipment, accessories, and parts; competitive discount prices; factory authorized sales, service, parts, systems design, installation. Write for free catalog! **Martin Audio/Video Corporation, 320 W. 46th St., New York, N.Y. 10036. (212) 541-5900.**

**MIXER MODULES:** modular construction provides economical route to studio-type mixing console; modules available with mic/line, pan, echo send, plastic element slide faders; equalization is also available as an add-on module. Typical cost of 6-in, 2-out mixer (no EQ) is less than \$450.00. Send for catalog. **Wall of Sound, Box 239, Glen Burnie, Md. 21061.**

**SCULLY, ELECTRO-VOICE, Neumann, Shure, Spectrasonics, Quad Eight, Masterroom, ARP, Crown, Microtak, Russco, dbx, Interface, EMT, and others. The Audio Marketplace, Div. United Audio Recording, 5310 Jackwood, San Antonio, Texas 78238. (512) 684-4000.**

**KING MODEL 800S TAPE WINDER** (hub); pre-recorded tape winder, will wind either 1/4 in. or 150 mil. widths; as new condition. Also used Rangertone resolver, as is. **Gary E. Taylor, Continental Film Productions Corp., P.O. Box 6543, Chattanooga, Tenn. 37408.**

**TUNED ROCK P.A.s** Customized high intensity touring/permanent installation sound systems, including narrow band (5 Hz!) feedback suppression, detailed regenerative response Acousta-Voicing/environmental equalization ( $\pm 1$  dB at your ears), room design/measurement/treatment,  $\leq 15\%$  articulation loss of consonants; 1000s of customized professional products, including fiberglass horns, consoles, comp/rms/peak limiters, 18 dB continuously variable electronic crossovers, digital/acoustic delays, omnipressors, phasors, reverb, echo, doubling/tripling effects, P.A. noise reduction; piezo transducers; frequency shifters from: J.B.L./Altec pro, Tascam, U.R.E.I., Eventide, Gately, Schoeps, Beyer, Crown, Community Light/Sound, Mom's Audio, McIntosh, Bozak, Allen & Heath, etc. etc. All shipped prepaid/insured. **Music & Sound, Ltd., 11 1/2 Old York Rd., Willow Grove, Pa. 19090. (215) 659-9251.**

**Inventors/Engineers**

**AMPEX AG-440** 2-track w/console, \$2,300; **Scully 280-2** w/console, \$2,600; **Scully 280B-2** w/console, \$2,995; **Neumann VG-2** cutting rack containing: LV-60 power amp. GV-2A feedback amp, SI-1 circuit breaker, WV-1 monitor amp, plus new ES-59 head, all for \$1,400. Contact Ron or Grant at: **Sound Recorders, 206 S. 44th St., Omaha, Nebraska 68131.**

**AUDIO BEEPER** for all audio-visual systems. For information call or write **C-TRONICS, P.O. Box 84, E. Brunswick, N.J. 08816. (201) 254-9487.**

**AUDIO PRO CLEANER . . .** the sensational new cleaner that eats up studio grime, makes your equipment look like new, cleans heads, tape guides, capstans . . . and everything else in the studio! Send \$11.95 for one gallon plus 8 oz. sprayer post paid to: **Audiotechniques, Inc., 142 Hamilton Ave., Stamford, Conn. 06902. (203) 359-2312.**

**WANT TO GO BI-AMP?**

**DeCoursey Electronic Dividing Networks** are available from \$89.10 (monaural bi-amp) to \$205.00 (stereo tri-amp). Price includes plug-in Butterworth filters; 6, 12, or 18 dB per octave at any desired cutoff frequency. **DeCoursey Engineering Laboratory, 11828 W. Jefferson Blvd., Culver City, Ca. 90230.**

**COHERENT CONCERT SOUND**—more than P.A.! We work with musicians to create an aural environment in concert that matches studio production. **(212) 947-1271.**

**AMPEX, SCULLY, TASCAM,** all major professional audio lines. Top dollar trade-ins. 15 minutes George Washington Bridge. **PROFESSIONAL AUDIO VIDEO CORPORATION, 342 Main St., Paterson, N.J. 07505. (201) 523-3333.**

**WHATEVER YOUR EQUIPMENT NEEDS**—new or used—check us first. We specialize in broadcast equipment. Send \$1.00 for our complete listings. **Broadcast Equipment & Supply Co., Box 3141, Bristol, Tenn. 37620.**

**DISCOTHEQUE MIXERS** from \$325.00; equalizer speakers with built-in power amplifiers; bi-amped systems and complete portable discotheque systems. Write us for literature. Dealer inquiries invited. **GLI, Box 2076, Dept. D, Brooklyn, N.Y. 11202. (212) 875-6992.**

**AUTOMATED QUAD PANNING**

**THE UNIQUE AQC SYSTEM (PAT. APPLIED FOR)**  
CAN DO WHAT HANDS CANNOT  
4, 8, 16 & 24 INPUTS  
**VIDEO & AUDIO ARTISTRY CORP**  
p.o. box 4571, boulder, colorado 80302  
**(303) 499-2001**

**B.B.C. REFERENCE MONITORS,** pre-equalized J. B. L./Altec monitors; **Dahlquist** phased arrays; **I. M. F.** transmission lines; **Infinity** electrostatics; **Crown/McIntosh** 16  $\Omega$ /bridged bi-amps; **Scully/Revox** A-700 recorders; **Micmix** reverbs; **Eventide** phasors/omnipressors; **Lexicon** digital delays; **dbx/Burwen** N.R. compressors; **Little Dipper** hum/buzz notch filters; **Cooper Time Cube** echo send; moving coil **Supex/Ortofon**; **B & O** straight line arms/cartridges; **Schoeps/AKG/Sennheiser** condensers; **Beyer** ribbons, **U.R.E.I.** comp/limiters/crossovers; **Gately** prokits; **Q.R.K.** tt. 1000s more. **Music & Sound Ltd., 11 1/2 Old York Rd., Willow Grove, Pa. 19090. (215) 659-9251.**

→ All Shipped Prepaid + Insured ←

**GOTHAM AUDIO CORP. LEASED EQUIPMENT SALE.** The items listed below were in use for less than one year and are therefore guaranteed to perform like new. **STUDER A-80** 2-in. 16-track with remote controller + 8-track conversion kit; **STUDER A-80 1/2-in.** 4-track; **STUDER B62** stereo w/console; **DOLBY M-16.** For special low prices call **(212) 741-7411.**

A FEW competitively priced used **Revox A77** decks available. Completely reconditioned by **Revox,** virtually indistinguishable from new and have the standard **Revox** 90-day warranty for rebuilt machines. Satisfaction guaranteed. Example, **A77** with **Dolby**, \$675, plus shipping. Write requirements to **ESSI, Box 854, Hicksville, N.Y. 11802. (516) 921-2620.**

**CROWN D1200, M600, and M2000;** drives **RTR "Monitor"** speakers, on demo now in our showroom. **Barclay Recording, 503 Haverford Ave., Narberth, Pa. (215) 667-3048.**

**WANTED**

**WANTED: AUDIO CONSOLE** (MCI, Spectrasonics, Electrodyne) 8/8 or larger). Must be in complete working order, factory-assembled. **Gaff Productions, 1725 S.W. 17th St., Ocala, Fla. 32670. (904) 732-4585.**

**EMPLOYMENT**

**POSITION DESIRED:** Recording experience on A.P.I. and Ampex. Career position desired; willing to relocate if offer secure. References. **Mario J. Salvati, 271 Third Ave., West Babylon, N.Y. 11704. (516) 893-0266.**



**FOR SALE**

**FOR SALE: STEREO DISC MASTERING SYSTEM**, Neumann transistor VG66 amplifier rack; SX68 cutterhead; AM32b variable pitch and depth lathe, with Leitz microscope, playback arm, suction system and stylus microscope; 2 racks with 2 Pultec EQPI-A; Fairchild 670 limiter, 2 in. oscilloscope, complete TRS jackfield, control panel with program and preview metering and controls; 2 Fairchild 688 amplifiers and 2 KLH4 speaker. Console with Ampex 300 deck, advance heads and 4 solid-state playback preamps. Best price over \$25,000. **Caedmon Records, 505 Eighth Ave., New York, N.Y. 10018. (212) 594-3122. Attn: Dan Wolfert.**

**AMPEX SERVICE COMPANY:** Complete factory service for Ampex equipment; professional audio; one-inch helical scan video; video closed circuit cameras; video systems; instrumentation and consumer audio. Service available at **2609 Greenleaf Avenue, Elk Grove Village, Ill. 60007; 500 Rodier Dr., Glendale, Ca. 91201; 75 Commerce Way, Hackensack, N.J. 07601.**

**BODE FREQUENCY SHIFTERS** since 1963 . . . Advanced designs for electronic music studios and high quality P.A. systems. New real time performance, synthesizer compatible model (patented features): \$995.00. Anti-feedback and special effects model with variable frequency shifts, down to 0.5 Hz.: \$575.00. Prices f.o.b. North Tonawanda. Delivery: stock to 6 weeks. For details and information on other models, write to: **Bode Sound Co., Harold Bode, 1344 Abington Place, N. Tonawanda, N.Y. 14120. (716) 692-1670.**

**INFINITY SS-1 SPEAKER SYSTEM**, \$1,200.00; Audio Research amplifiers: D76, \$700.00, D51, \$450.00. **(516) 889-3777.**

**DYNACO RACK MOUNTS** for all Dynaco preamps, tuners, integrated amps. \$24.95 postpaid in U.S., \$22.50 in lots of three. **Audio by Zimet, 1038 Northern Blvd., Roslyn, N.Y. 11576. (516) 621-0138.**

**THE LIBRARY . . .** Sound effects recorded in STEREO using Dolby throughout. Over 350 effects on ten discs, \$100.00. Write, **The Library, P.O. Box 18145, Denver, Colorado 80218.**

DYMA builds roll-around consoles for any reel-to-reel tape recorder. **Dyma Engineering, Route 1, Box 51, Taos, New Mexico 87571.**

**FREE CATALOG & AUDIO APPLICATIONS**



CONSOLES  
KITS & WIRED  
AMPLIFIERS  
MIC., EQ, ACN,  
LINE, TAPE, DISC,  
POWER  
OSCILLATORS  
AUDIO  
TAPE BIAS  
POWER SUPPLIES

**OPAMP LABS, INC.**  
1023 N. SYCAMORE AVE  
LOS ANGELES CALIF 90038  
2131 934 3346

**REPAIR**

SCHOEPS (TELEFUNKEN) VACUUM TUBE  
CONDENSER MICROPHONES REPAIRED.  
Original factory parts & factory calibration of capsules.  
Models CM51, 61, 66; M201, 221; MK24, 26 etc.

ALBERT B. GRUNDY  
64 University Pl., N.Y., N.Y. 10003  
(212) 929-8364

**MODERN RECORDING TECHNIQUES** by Robert E. Runstein. The only book covering all aspects of multi-track pop music recording from microphones through disc cutting. For engineers, producers, and musicians, \$9.95 prepaid. **The Great Northern Recording Studio, Ltd. Box 206, Maynard, Mass. 01754.**

**TASCAM REVERBS—\$500;** Tascam mixing consoles—\$2,350; Tascam 1/2-inch recorders—\$2,750; Tascam 8-track recorders—\$4,600. All shipped prepaid/insured, including free alignment/equalization/bias/calibration. **Music & Sound, Ltd., 11 1/2 Old York Rd., Willow Grove, Pa. 19090. (215) 659-9251.**

**SINGLE EDGE RAZOR BLADES**, tape editing. \$23/M. Flyer. **RALTEC, 25884 Highland, Cleveland, Ohio 44143.**

DYMA builds custom studio consoles, desks, enclosures, studio furniture. **Dyma Engineering, Route 1, Box 51, Taos, New Mexico 87571.**



**WORAM AUDIO ASSOCIATES**  
Consultants in Studio Systems  
Engineering, Design and Installation

—offering—

**A COMPLETE CONSULTATION  
SERVICE FOR STUDIO  
PLANNING AND  
CONSTRUCTION**

**FREE-LANCE RECORDING  
SERVICE IN THE  
NEW YORK AREA**

**212 673-9110**  
**64 University Place**  
**New York, N.Y. 10003**



**Timekeeper  
TO-1  
Hand-  
Held  
Oscillator**

*Don't let its size or price fool you!*

The TO-1 is a new pocket size battery powered test oscillator specifically designed for testing, aligning, and troubleshooting audio equipment, transmission lines and systems. It permits testing of frequency response, distortion, gain, crosstalk and noise for almost any type of equipment. Its performance and specs are of the highest standards, making it an indispensable tool for audio measurements and maintenance, yet it easily slips into your shirt pocket!

**TO-1 SPECIFICATIONS**

- Switch selectable frequencies:  
30 Hz, 400 Hz, 1 kHz, 15 kHz
- Balanced outputs:  
+4 dBm and -56 VU into 200 ohms
- Frequency response: ±0.1 dB
- THD (total harmonic distortion):  
less than 0.05%
- Frequency accuracy: ±5%
- Frequency stability:  
2% for temp. 32-104 degrees F.
- Source (output) impedances:  
600 ohms ±5% at +4 dBm,  
200 ohms ±5% at -56 VU
- Current drain: 5 mA with 9V supply
- Size: 7 1/4" x 2" x 1"
- Weight: 6 oz. (169 gm)

Designed to feed a 600 ohm line at ±4 dBm, the TO-1 balanced output can feed any patch bay using a simple patch cord. A calibration curve supplied with the unit indicates the output level for other load impedances as well. An internal trim pot provides an additional variation of oscillator output.

For testing purposes, the TO-1 can be used as any other type of high quality audio oscillator with the additional ability to truly resemble a floating balanced signal source, with distortion and noise levels matching the best available microphone. It is a perfect substitute for any unbalanced signal source as well.

Since it is battery operated, it can be used as a portable test oscillator in practically any field situation. At its low price, it can be an indispensable tool in any studio, shop or station.

The TO-1 carries a 1-year warranty. To order, send check for \$59.95 (includes shipping costs) (N.Y. State residents add 7% sales tax) to:

**TIMEKEEPER**  
**Box 35, Great Neck, N.Y. 11021**



KASSENS



MILLER



CICCONE



TRAUSCH

● **Harold L. Kassens**, former assistant chief of the **FCC Broadcast Bureau**, has become a partner in the consulting engineering firm of **A. D. Ring & Associates** of Washington, D.C. Other partners in the firm, which was established in 1941, are **A. D. Ring, Dr. Frank G. Kear, Howard T. Head, Marvin Blumberg, and Ogden Prestholdt**. Mr. Kassens is well known in the broadcast industry because of his activity in f.m. stereophonic and quadriphonic broadcasting, as well as his work in broadcast re-regulation and broadcast allocations.

● Hi fi veteran **Paul Miller** has joined **Maxell Corporation of America**, of Moonachie, N.J. as product/advertising manager. Mr. Miller comes from **Altec**, where he was product manager, and formerly served with **Ampex** and **Reeves Soundcraft**.

● **Arthur A. Schubert, Jr.** has joined **Ward-Beck Systems, Ltd.** of Scarborough, Ontario as director of engineering. Mr. Schubert served in the **CBS** television engineering department before coming to Ward-Beck. Previously to that, he worked in England as chief development engineer for **Neve Electronic Laboratories, Ltd.** In his new position, he will be responsible for engineering management in the design and production of Ward-Beck audio consoles and related products.

● The 117th Technical Conference and Equipment Exhibit of the **Society of Motion Picture and Television Engineers (SMPTE)** will be held at the Century Plaza hotel in Los Angeles, September 28 to October 3. This will be the first year in which SMPTE will hold only one conference instead of two in order to consolidate costs to exhibitors. For information, write to SMPTE Conference, 862 Scarsdale Ave., Scarsdale, N.Y. 10583.

● **RCA International, Ltd.** has established a new regional office in the

London, England area to service the European and African markets. The office will be headquarters of **Commercial Communications Systems—Europe, Middle East, and Africa**. It will be located at Lincoln Way, Windmill Rd., in Sunbury-on-Thames. **Patrick J. Murrin** has been designated vice president in charge of the new facility.

● A new northeastern regional office, based in Boston, has been established by **Electro Sound, Inc.** The office will be headed by sales manager **Joseph C. Ciccone**. His territory will include all states from Virginia on the south to Canada on the north, and west from the Atlantic seaboard through Pennsylvania. He will also service Canada west to Toronto. Mr. Ciccone comes to **Electro Sound** from the **Data Packaging Corporation** and was also associated with **RCA**.

● **Charles Trausch** has been named midwest manager for **Capitol Magnetic Products**, a division of **Capitol Records**. His responsibilities include the sale of music tape and professional products manufactured under the Audio label. Mr. Trausch has been with Capitol since 1970 and previously was associated with **Totel Systems**.

● **CCA Electronics Corporation** of Gloucester City, N.J. has announced the appointment of **A. W. Trueman** to the position of director of engineering. Mr. Trueman came to CCA from his own consulting firm. Prior to that he was with **RCA**.

● Three educational companies have been purchased by **International Audio Visual** of Van Nuys, Ca. from **Alco Standard** of Pennsylvania. The companies include **Standard Projector and Equipment Company, Electronic Systems for Education, and Educational Projections Company**. The combination of resources from the new companies will be utilized to produce new

equipment for educational audio, such as a new i.e.d. device for transmitting video and audio information and new miniaturized audio systems.

● A decision has been reached by prestigious **A & M Records** to assign their long-term quad commitment to the CD-4 discrete record system. This came about after considerable experimenting with all three of the major quad systems. The nod to CD-4 by A & M is regarded by many in the industry as a major triumph for the discrete form as opposed to matrix quad.

● A ten week course in the art of multi-track recording is being offered by the **Recording Institute of America**, 6565 Sunset Boulevard, Los Angeles, Ca. 90028 at forty locations throughout the country. Students learn to operate equipment such as the control console, multi-track recorders, equalizers, limiters, noise reduction units, etc. and receive instruction in techniques of microphone selection and placement, patching, overdubbing, mixing and editing. The course features a two-week experience with live 16-track recording and mix down sessions.

● Focalizing customer services, **Bill Hamilton** has been appointed regional sales manager of the **Auditronics Systems Division**, of Memphis, Tenn. Mr. Hamilton will be based in Philadelphia. His duties will include providing assistance to recording studios with equipment, system design, acoustic design, and financing.

● Two subsidiaries of **Filmways, Inc.** of Los Angeles have been consolidated to form a new Broadcast and Sound Services group. **Broadcast Electronics, Inc.** of Silver Spring, Maryland and **Wally Heider Recording Studios** of Hollywood and San Francisco, Ca. will be unified under the same executive direction. The group will be headed by **Andrew Szegda**, president of Broadcast Electronics.

● **H. N. Larkin** has been appointed to the newly created position of vice president for marketing at the **Ampro Corporation**, of Willow Grove, Pa. Mr. Larkin comes from the **Control Design Corporation**. **Edward N. Mullin**, who has been with the firm since its inception, has been promoted to the position of vice president for engineering at Ampro.



# Our 8 Tracks on Half-Inch tape Vs. Their 8 Tracks on One-Inch tape



**With the money you save on ours  
you can buy a board to go with it.**

Our new Series 70 8-Track is for people who need a good, but inexpensive multitrack machine. People with an 8-track application and a 4-track budget.

#### **The Professional Alternative**

The standard in the industry calls for high level, low impedance, half-track formats. That technology is no secret (we can give you a high level, low impedance version), but the point is you probably don't need it. And if you don't need it, why pay for it?

We pioneered the quarter-track format in multi-channel recorders and we've probably built more of them than all our

competitors combined. We introduced the design philosophy of low level, high impedance signal processing in mixing consoles (the first first from TASCAM). And it worked.

#### **You need it. Now you can afford it.**

The true test of what goes on a tape is what comes off; quality is as much a matter of talent as tools. If you want professional quality and you're willing to work with a tape recorder to get it, take half the tape width for about half the price of a one-inch machine and see the Series 70 8-Track at your TASCAM dealer soon. For your nearest dealer just call (800) 447-4700. In Illinois: (800) 322-4400. We'll pay for the call.

**8-Tracks on Half-Inch tape.  
The second first from TASCAM.**

© TEAC 1974



**TASCAM**  
TEAC PROFESSIONAL PRODUCTS

# Sometimes you want lots of proximity effect.

**"The Mike With Guts."  
E-V's New 671  
Single-D Cardioid.**

Proximity effect. It's that husky bass boost a singer gets working close to the mike. It's just one of the things our new 671 does better than other mikes. Make a comparison test. We think you'll find that the 671 provides greater gain before feedback than the mike you are using now—or any competitive mike. You'll also find that our sophisticated shock mounting assures superior rejection of handling noise. And it's got all the tough-as-nails ruggedness you expect from an Electro-Voice microphone.

# Sometimes you don't.

**"The Clean  
Mike." E-V's  
New 660/661  
Continuously  
Variable-D<sup>®</sup>  
Super Cardioid.**

Successor to the famed 664 ("The Buchanan Hammer"), our new 660/661 minimizes proximity effect to deliver clear, crisp sound at any working distance. Frequency response, both on and off axis, is continuously smooth and uniform. Rear sound rejection capabilities are excellent. The 660/661 mike is the one mike for doing the most jobs best. The same professional performance as our famous RE series at less than professional price.

The 661 has a high/low impedance switch. The 660 and 671 have no-solder impedance change that takes less than a minute.

A98105KUOWA325COM11 2067901 DB  
KUOW RADIO  
D 5 50 UNIV OF WASH  
325 COMMUNICATIONS BLDG  
SEATTLE WA 98105

**Electro-Voice** INC. a **gulton** company

660 clam-mounted...\$72.00, 661 stud-mounted...\$75.00; 671...  
\$68.70 (suggested resale net— slightly higher in western states).

Electro-Voice, Inc. Dept. 652BD, 686 Cecil Street Buchanan, Michigan 49110

Circle 11 on Reader Service Card